

LEADER

by SIGNAL SIGN SYSTEMS LTD



EDGE

WAYFINDING SIGN SYSTEM

3
FLOOR

WEST WING - 3rd FLOOR
COURT ROOMS A - B ←
COURT ROOMS C - D →
LAW LIBRARY →
CAFETERIA →

IN CASE OF FIRE
DO NOT USE ELEVATORS
USE STAIRS

CAFETERIA →

RESTROOMS

RESTROOM

EVACUATION PLAN

Signal
sign systems

www.signal-sign.com

LEADER EDGE

About Leader Edge

The Leader Edge features a thin flat faced frame system (10.6mm - 0.042") with a slightly curved ultra slim edge (1.8mm - 0.070"), creating one of the industry's cleanest looking, elegant aluminum frame systems. The variety of sizes and special designs is endless. The extrusions design allow the use of a variety of insert materials and decorative techniques.

The sign face can be made from a variety of flat sheet materials up to 3mm (0.125") thick such as: Acrylic, aluminum, composite aluminum panel, glass, wood, etc.

The Leader Edge is offered as a perimeter frame profile that can be ordered in almost any desired size, and three economical full wide body profiles 55, 107, 153mm (2", 4", 6") use ABS end caps for standard room sign units that can be cut to any desired length.

A molded injected ABS end caps for the 3 economy profiles are available in 3 finishes: Grey, black and a unique shiny chrome plated.

The Leader Edge offers a complete wayfinding solution, from door signs, table stands, projecting flags, suspended signs to directories. The endless design options combined with the latest digital printing abilities makes the Leader Edge a perfect choice for your next signage project.

- **LEF** Leader Edge Frames - uniform edge frames
- **LE-L** Leader Edge economy wall frames Landscape
- **LE-P** Leader Edge economy wall frames Portrait
- **LEF-D-L** Leader Edge Frames- medium-large sizes
- **LEF-D-P** Leader Edge Frames Directory Portrait
- **LE-DS-L** Leader Edge Double Sided suspended signs Landscape
- **LEF-D-DS-P** Leader Edge Frames Directory Double Sided suspended signs Portrait
- **LEPF-L** Leader Edge Projecting Flags Landscape
- **LEFPF-P** Leader Edge Frames Projecting Flags Portrait
- **LETS** Leader Edge Table Stands



WAYFINDING SIGN SYSTEM



LEF is the basic Leader Edge configuration. It is a thin flat-faced frame system (only 10.6mm – 0.42”) with a slim edge (only 1.8mm-0.070”), creating one of the industry’s most elegant and cleanest looking aluminum frame system.

The angle cut profiles are joined together using a metal corner bracket and are secured with a specially designed punching tool to achieve a clean corner joint.

We offer three configurations of the LEF to choose from:

CC - A frame with a thin lightweight PVC layer and a clear cover lens for use with a printed paper insert.

DBM - A frame with a solid composite aluminum face and magnetic self-adhesive strips on the back providing easy insertion and removal, for use with direct printing or vinyl graphics.

FF – An assembled frame with no faces for use with all other face materials up to 3mm (0.125”) thick.

The LEF is offered in a wide variety of sizes ranging between 75mm x75mm (3”x3”) and 300mm x 500mm (12” x 20”). For larger units, it is recommended to use the LEF-D units. Commonly used sizes are presented; however, customized sizes are available upon request.

Installation is very simple. A double-sided self-adhesive tape can be applied to the back of the frame, or concealed screws can be used as well through the built-in channels.





1

LEF – CC .A frame with a thin lightweight PVC layer and a clear cover lens for use with a printed paper insert. An easy insert removal using our silicone suction cup.

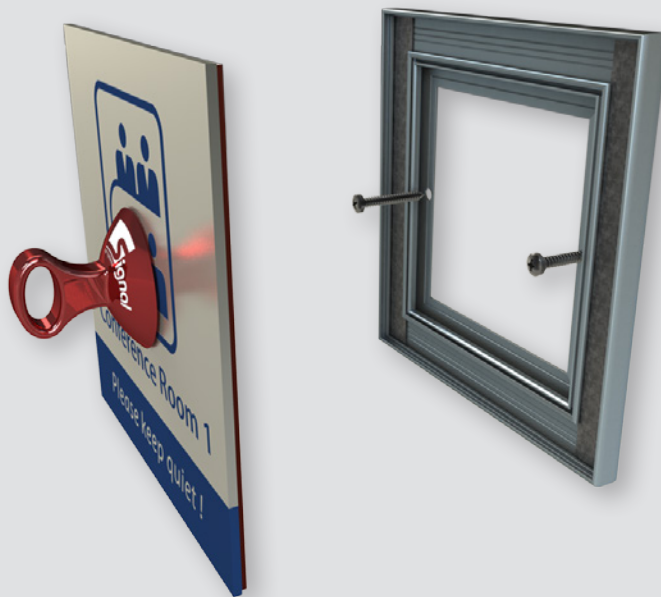

2

LEF-DBM . A frame with a solid composite aluminum face and magnetic self-adhesive strips on the back.

LEF-H-W	
LEF	System Type - Leader Edge Frame
H	Sign Unit Height - mm
W	Sign Unit Width - mm

The LEF angle cut profiles are joined together using a metal corner brackets and are secured with a specially designed punching tool to achieve a clean corner joint.

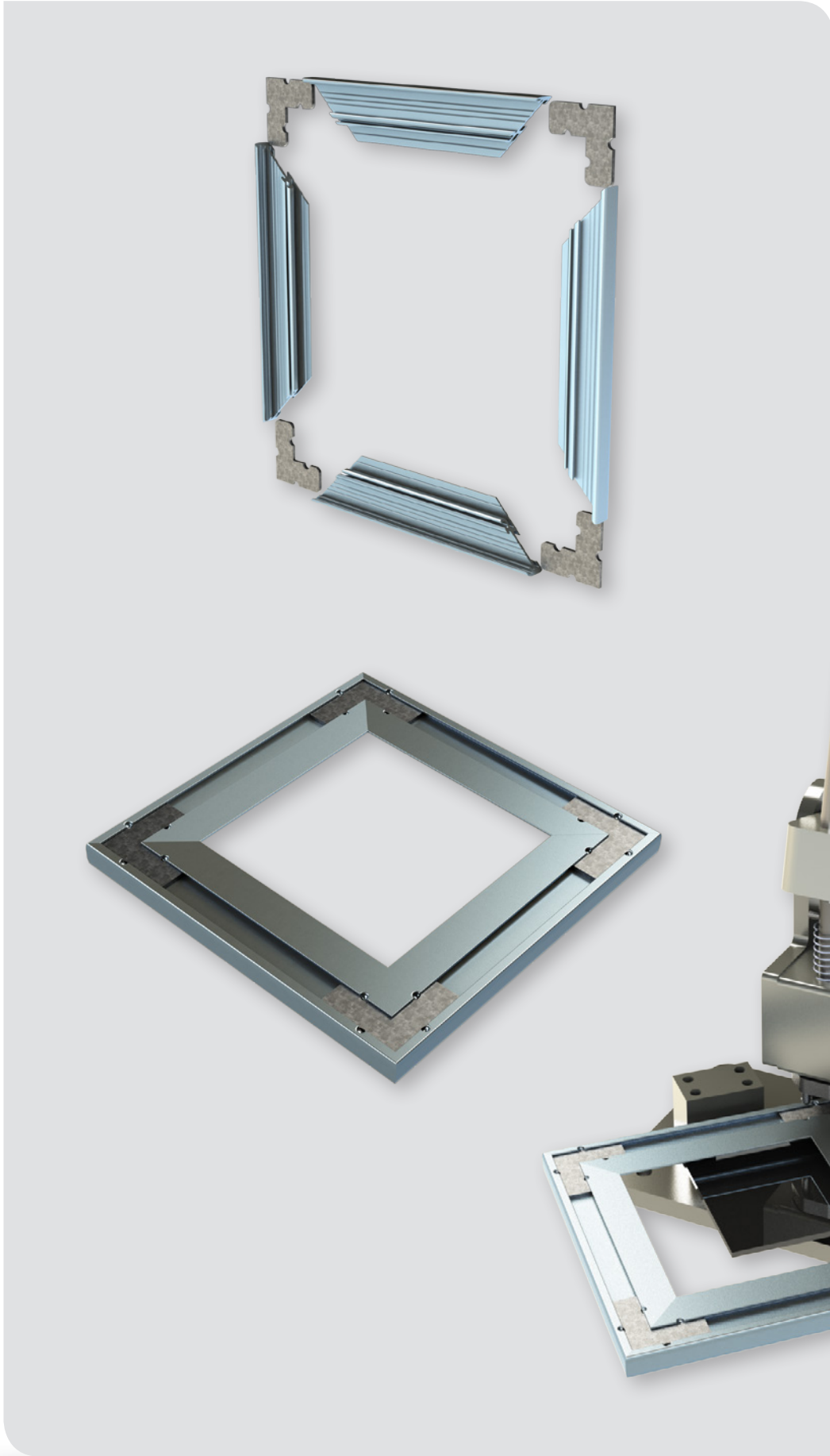

LEF-75

Commonly used unit size (other unit size can be ordered by demand)

Paper Insert Size = Overall - 3mm
Hard Panel Face Size = Overall - 4mm

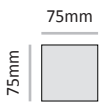
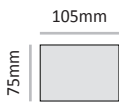
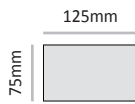
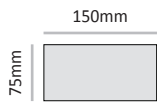
			
Cat. No. LEF-75-75 Unit Size HxW 75mm x 75mm	Cat. No. LEF-75-105 Unit Size HxW 75mm x 105mm	Cat. No. LEF-75-125 Unit Size HxW 75mm x 125mm	Cat. No. LEF-75-150 Unit Size HxW 75mm x 150mm

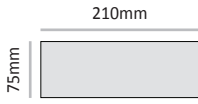
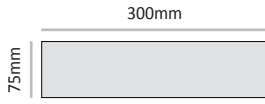
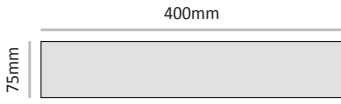

		
Cat. No. LEF-75-210 Unit Size HxW 75mm x 210mm	Cat. No. LEF-75-300 Unit Size HxW 75mm x 300mm	Cat. No. LEF-75-400 Unit Size HxW 75mm x 400mm

LEF-105

Commonly used unit size (other unit size can be ordered by demand)

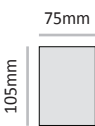
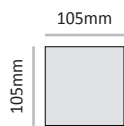
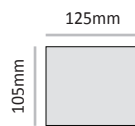
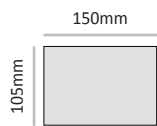
Paper Insert Size = Overall - 3mm
Hard Panel Face Size = Overall - 4mm

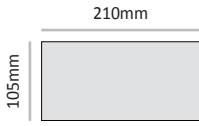
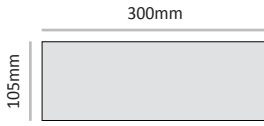
			
Cat. No. LEF-105-75 Unit Size HxW 105mm x 75mm	Cat. No. LEF-105-105 Unit Size HxW 105mm x 105mm	Cat. No. LEF-105-125 Unit Size HxW 105mm x 125mm	Cat. No. LEF-105-150 Unit Size HxW 105mm x 150mm

		
Cat. No. LEF-105-210 Unit Size HxW 105mm x 210mm	Cat. No. LEF-105-300 Unit Size HxW 105mm x 300mm	Cat. No. LEF-105-400 Unit Size HxW 105mm x 400mm

LEF-125

Commonly used unit size (other unit size can be ordered by demand)

Paper Insert Size = Overall - 3mm
Hard Panel Face Size = Overall - 4mm

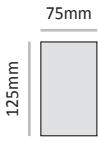

Cat. No. LEF-125-75
Unit Size HxW 125mm x 75mm

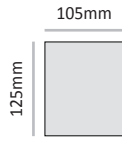

Cat. No. LEF-125-105
Unit Size HxW 125mm x 105mm

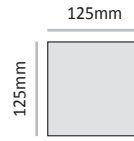

Cat. No. LEF-125-125
Unit Size HxW 125mm x 125mm

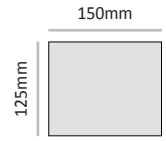

Cat. No. LEF-125-150
Unit Size HxW 125mm x 150mm

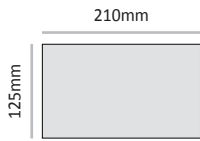

Cat. No. LEF-125-210
Unit Size HxW 125mm x 210mm

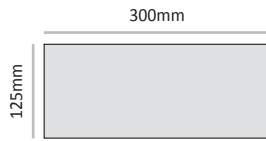

Cat. No. LEF-125-300
Unit Size HxW 125mm x 300mm

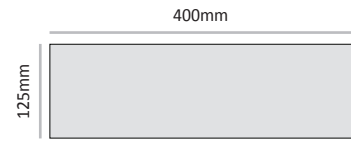

Cat. No. LEF-125-400
Unit Size HxW 125mm x 400mm

LEF-150

Commonly used unit size (other unit size can be ordered by demand)

Paper Insert Size = Overall - 3mm
Hard Panel Face Size = Overall - 4mm

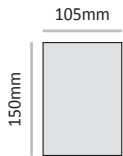

Cat. No. LEF-150-105
Unit Size HxW 150mm x 105mm

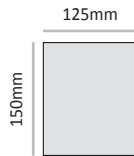

Cat. No. LEF-150-125
Unit Size HxW 150mm x 125mm

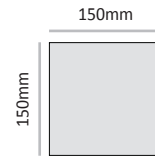

Cat. No. LEF-150-150
Unit Size HxW 150mm x 150mm

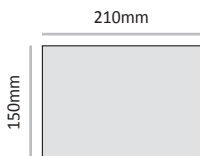

Cat. No. LEF-150-210
Unit Size HxW 150mm x 210mm



Cat. No. LEF-150-300
Unit Size HxW 150mm x 300mm

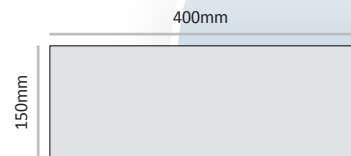

Cat. No. LEF-150-400
Unit Size HxW 150mm x 400mm

LEF-210

Commonly used unit size (other unit size can be ordered by demand)

Paper Insert Size = Overall - 3mm
Hard Panel Face Size = Overall - 4mm

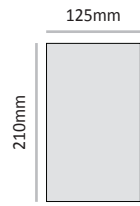

Cat. No. LEF-210-125
Unit Size HxW 210mm x 125mm

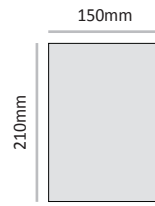

Cat. No. LEF-210-150
Unit Size HxW 210mm x 150mm

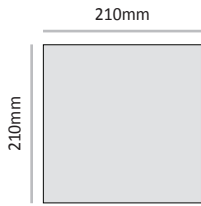

Cat. No. LEF-210-210
Unit Size HxW 210mm x 210mm

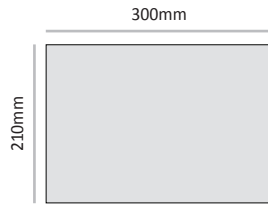

Cat. No. LEF-210-300
Unit Size HxW 210mm x 300mm

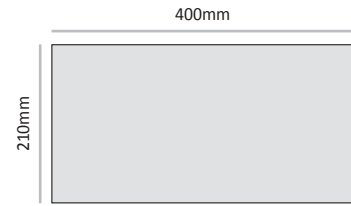

Cat. No. LEF-210-400
Unit Size HxW 210mm x 400mm

LEF-300

Commonly used unit size (other unit size can be ordered by demand)

Paper Insert Size = Overall - 3mm
Hard Panel Face Size = Overall - 4mm



Cat. No. LEF-300-150
Unit Size HxW 300mm x 150mm

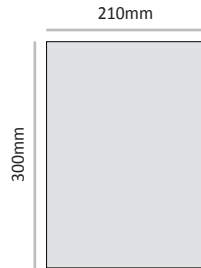

Cat. No. LEF-300-210
Unit Size HxW 300mm x 210mm

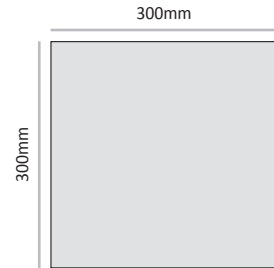

Cat. No. LEF-300-300
Unit Size HxW 300mm x 300mm

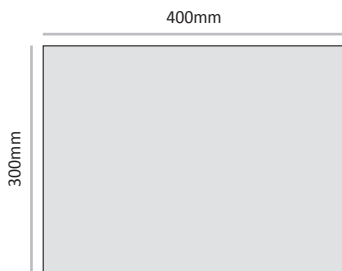

Cat. No. LEF-300-400
Unit Size HxW 300mm x 400mm

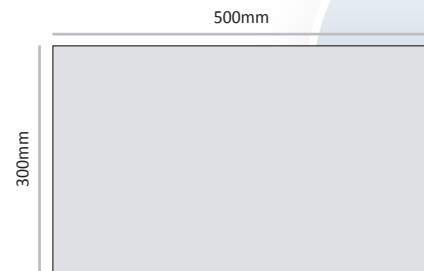

Cat. No. LEF-300-500
Unit Size HxW 300mm x 500mm

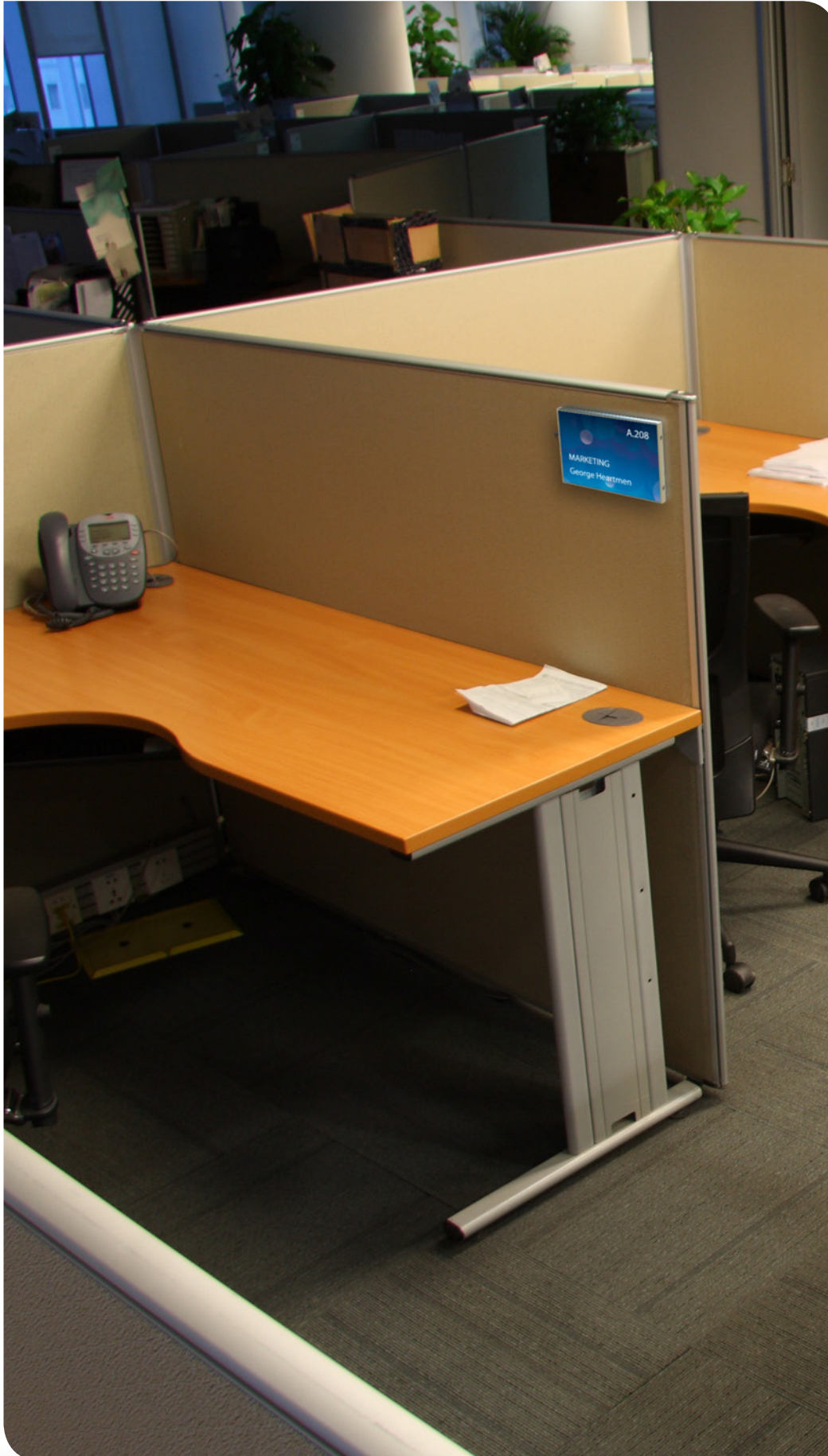

LE-L is the economic Leader Edge landscape wall frame option.

The LE-P is offered in three profile height options: 55, 107 and 153mm (2", 4", 6") in unlimited length options.

The economy version consists of three solid extrusion options cut to any desired length and uses specially designed injected ABS end caps that reproduce the unique appearance of the Leader Edge's unique side profile.

The ABS plastic end caps are available in three finishes to choose from: Grey, black and chrome plated.

Commonly used width options are presented; however, customized widths are available upon request.

A variety of insert materials such as printed paper, ADA photopolymer, engraved PVC, etched thin aluminum, silk printed plaques and many other inserts up to 1.6mm (0.060") thick, can be used to create limitless designs.

The smooth surface of the LE-L profiles is suitable for direct application of vinyl graphics. All units are supplied with a clear polycarbonate protective lens which can be removed using our silicone suction cup for an easy insert/removal.

The installation is very simple; a double-sided self-adhesive tape can be applied to the back of the frame, or concealed screws can be used as well through the built-in channels.

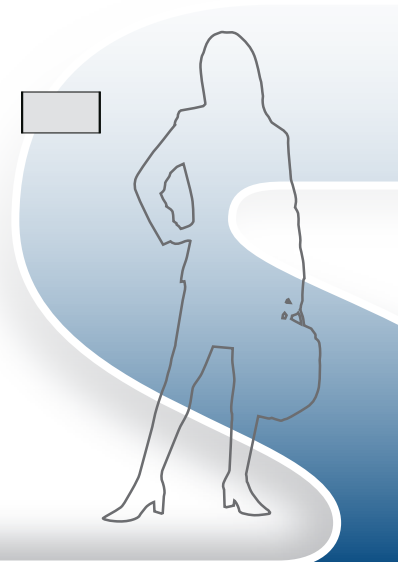



1

The ABS plastic end caps are available in three finishes to choose from: Grey, black and chrome plated.



2

An easy insert removal using our silicone suction cup.

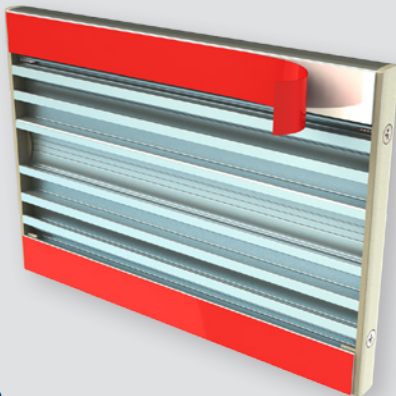

3

An easy installation using double sided self-adhesive tape on the back.



4

LE-L is offered in three profile height options: 55, 107 and 153mm (2",4",6"), with unlimited length options.

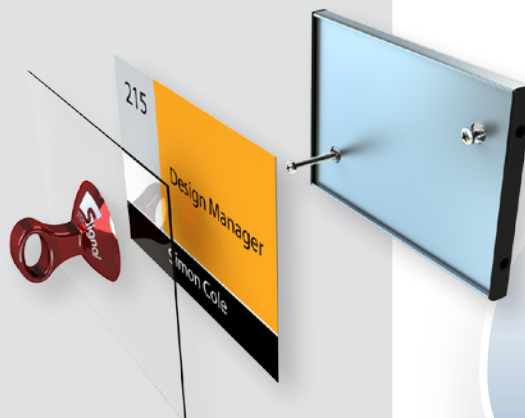

5

Installation using concealed screws through the built-in channels.

LE-L-H-W-EC	
LE	System Type - Leader Edge
L	Sign layout - Landscape
H	Sign Unit Height - mm
W	Sign Unit Width - mm
EC	End caps finish GR - Grey BK - Black CR - Chrome Plated

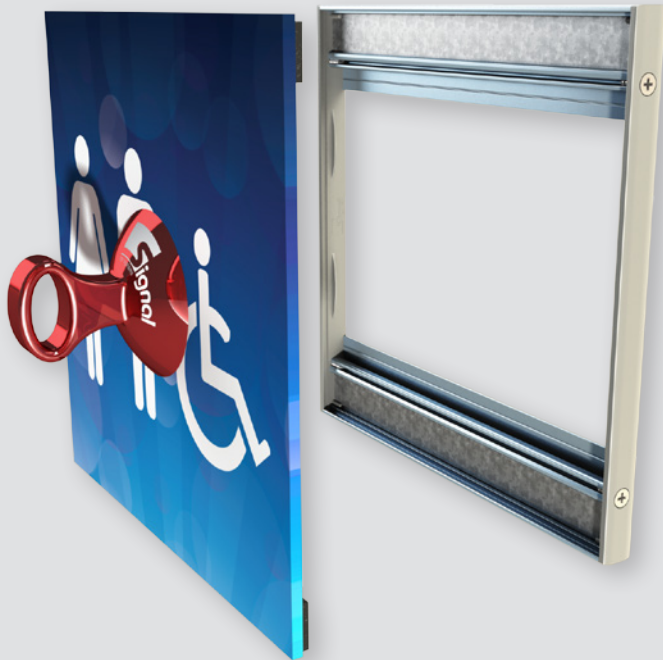

The LE-L-DBM offers a cheaper option for the LEF configuration as it is using the ABS injected end caps instead of a perimeter frame, saving labor and weight.

The LE-L-DBM allow the use of rigid thicker face panels such as solid composite aluminum boards or other materials like acrylic, glass, wood etc' up to 3mm (0.125") thick with magnetic self-adhesive strips on the back providing easy insertion and removal, for use with direct printing or vinyl graphics.

The LE-L-DBM is available in two units height option: 107,153mm (4",6").

LE-L-55

Commonly used unit width (other unit width can be ordered by demand)



Cat. No.	LE-L-55-75
Unit Width	75 mm
Insert size	52mm X 75mm

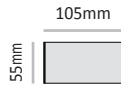

Cat. No.	LE-L-55-105
Unit Width	105 mm
Insert size	52mm X 105mm

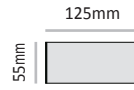

Cat. No.	LE-L-55-125
Unit Width	125 mm
Insert size	52mm X 125mm

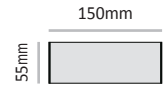

Cat. No.	LE-L-55-150
Unit Width	150 mm
Insert size	52mm X 150mm

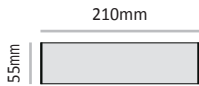

Cat. No.	LE-L-55-210
Unit Width	210 mm
Insert size	52mm X 210mm

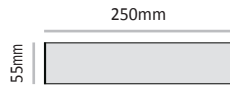

Cat. No.	LE-L-55-250
Unit Width	250 mm
Insert size	52mm X 250mm

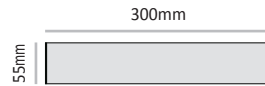

Cat. No.	LE-L-55-300
Unit Width	300 mm
Insert size	52mm X 300mm

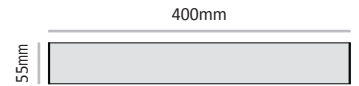

Cat. No.	LE-L-55-400
Unit Width	400 mm
Insert size	52mm X 400mm

LE-L-107

Commonly used unit width (other unit width can be ordered by demand)

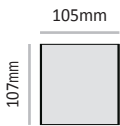

Cat. No.	LE-L-107-105
Unit Width	105 mm
Insert size	105mm X 105mm

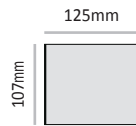

Cat. No.	LE-L-107-125
Unit Width	125 mm
Insert size	105mm X 125mm

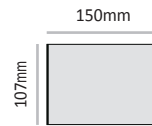

Cat. No.	LE-L-107-150
Unit Width	150 mm
Insert size	105mm X 150mm

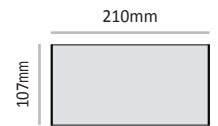

Cat. No.	LE-L-107-210
Unit Width	210 mm
Insert size	105mm X 210mm



Cat. No.	LE-L-107-250
Unit Width	250 mm
Insert size	105mm X 250mm

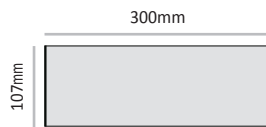

Cat. No.	LE-L-107-300
Unit Width	300 mm
Insert size	105mm X 300mm

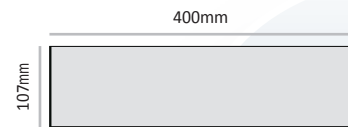

Cat. No.	LE-L-107-400
Unit Width	400 mm
Insert size	105mm X 400mm

LE-L-153

Commonly used unit width (other unit width can be ordered by demand)

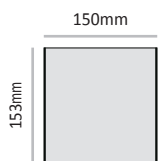

Cat. No.	LE-L-153-150
Unit Width	150 mm
Insert size	150mm X 150mm

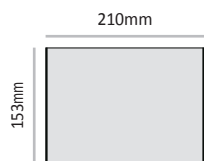

Cat. No.	LE-L-153-210
Unit Width	210 mm
Insert size	150mm X 210mm

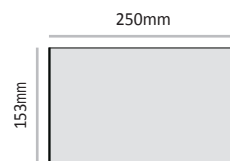

Cat. No.	LE-L-153-250
Unit Width	250 mm
Insert size	150mm X 250mm



Cat. No.	LE-L-153-300
Unit Width	300 mm
Insert size	150mm X 300mm



Cat. No.	LE-L-153-400
Unit Width	400 mm
Insert size	150mm X 400mm



Cat. No.	LE-L-153-500
Unit Width	500 mm
Insert size	150mm X 500mm



Cat. No.	LE-L-153-600
Unit Width	600 mm
Insert size	150mm X 600mm



LE-P is the economic Leader Edge portrait wall frame option. The LE-P is offered in two widths: 107mm and 153mm (4", 6") with unlimited height options.

This economy version is an affordable full wide body extrusion cut to any desired length and uses specially designed injected ABS end caps that reproduce the unique appearance of the Leader Edge side profile.

The ABS plastic end caps are available in three finishes to choose from: Grey, black and chrome plated.

Commonly used height options are presented; however, customized heights are available upon request.

A variety of insert materials such as printed paper, ADA photopolymer, engraved PVC, etched thin aluminum, silk printed plaques up to 1.6mm (0.060") thick, amongst others, can be used to create limitless designs.

The smooth surface of the LE-P profile is suitable for direct application of vinyl graphics. All units are supplied with a clear polycarbonate protective lens which can be removed using our silicone suction cup for easy insert/removal.

The installation is very simple. A double-sided self-adhesive tape can be applied to the back of the frame, or concealed screws can be used as well through the built-in channels.

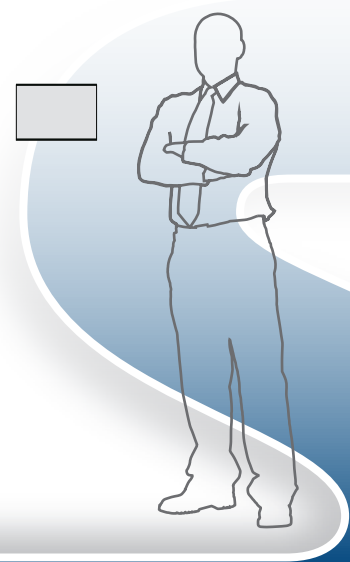



1

LE-P is offered in two profile height options: 107 and 153mm (4",6") , with unlimited height options.



2

The ABS plastic end caps are available in three finishes to choose from: Grey, black and chrome plated.

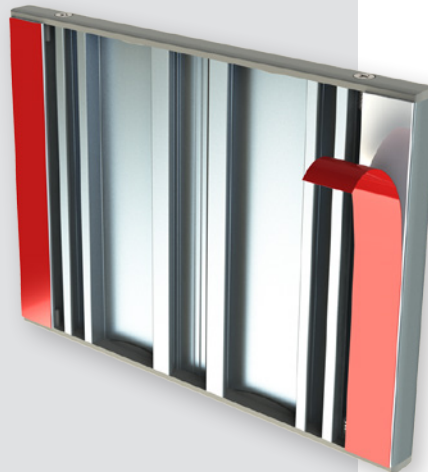

3

An easy installation using double sided self-adhesive tape on the back.

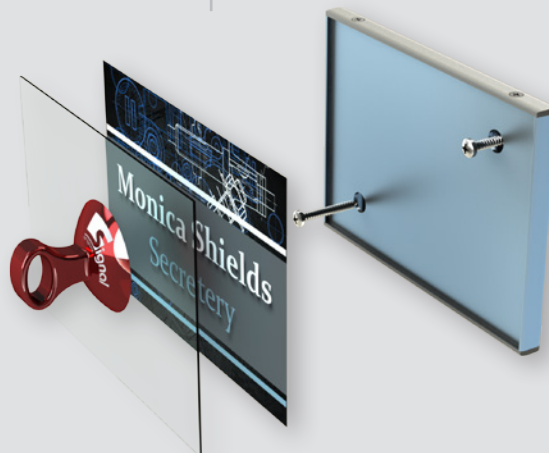

4

Installation using concealed screws through the built-in channels.

LE-P-W-H-EC	
LE	System Type - Leader Edge
P	Sign layout - Portrait
W	Sign Unit Width - mm
H	Sign Unit Height - mm
EC	End caps finish GR - Grey BK - Black CR - Chrome Plated

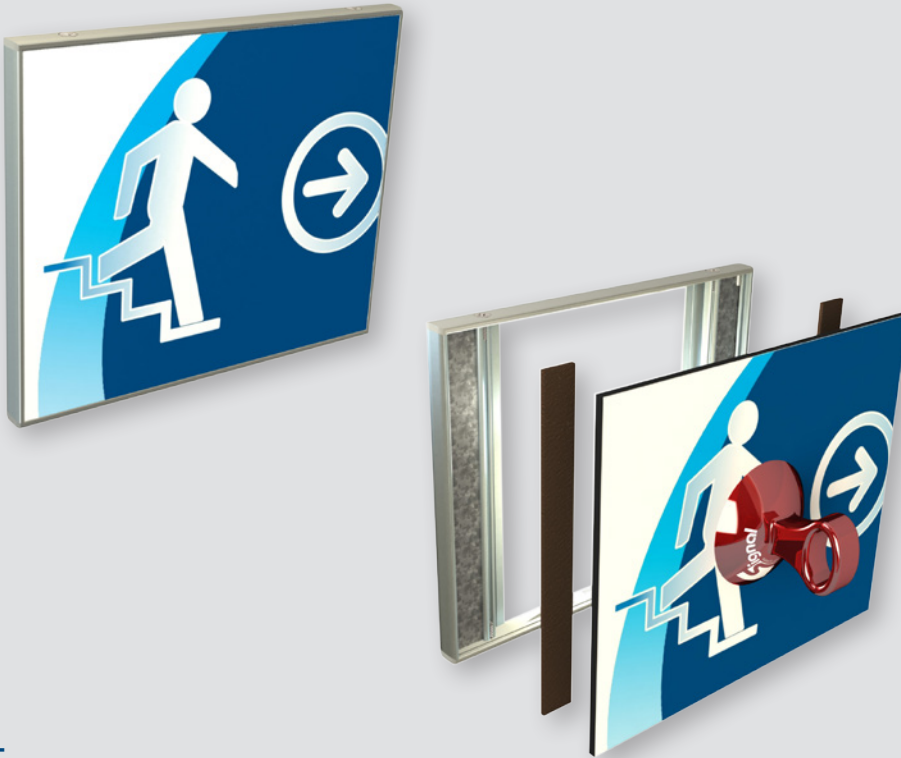

5

LE-P-DBM a wall frame with a rigid face board and ABS end caps.

The LE-P-DBM offers a cheaper option for the LEF configuration as it is using the ABS injected end caps instead of a perimeter frame, saving labor and weight.

The LE-P-DBM allow the use of rigid thicker face panels such as solid composite aluminum boards or other materials like acrylic, glass, wood etc' up to 3mm (0.125") thick with magnetic self-adhesive strips on the back providing easy insertion and removal, for use with direct printing or vinyl graphics.

The LE-P-DBM is available in two units width option: 107,153mm (4", 6").



6

A divided wall frame unit with a permanent header strip and an interchangeable strip.

LE-P-107

Commonly used unit height (other unit height can be ordered by demand)



Cat. No.	LE-P-107-50
Unit Height	50 mm
Insert size	105mm X 50mm

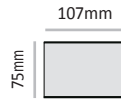

Cat. No.	LE-P-107-75
Unit Height	75 mm
Insert size	105mm X 75mm

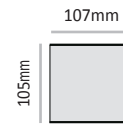

Cat. No.	LE-P-107-105
Unit Height	105 mm
Insert size	105mm X 105mm

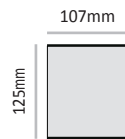

Cat. No.	LE-P-107-125
Unit Height	125 mm
Insert size	105mm X 125mm

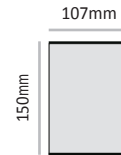

Cat. No.	LE-P-107-150
Unit Height	150 mm
Insert size	105mm X 150mm

LE-P-153

Commonly used unit height (other unit height can be ordered by demand)

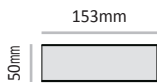

Cat. No.	LE-P-153-50
Unit Height	50 mm
Insert size	150mm X 50mm

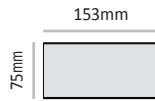

Cat. No.	LE-P-153-75
Unit Height	75 mm
Insert size	150mm X 75mm

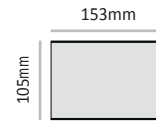

Cat. No.	LE-P-153-105
Unit Height	105 mm
Insert size	150mm X 105mm

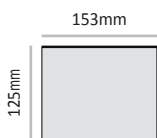

Cat. No.	LE-P-153-125
Unit Height	125 mm
Insert size	150mm X 125mm

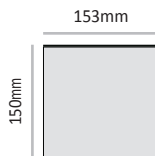

Cat. No.	LE-P-153-150
Unit Height	150 mm
Insert size	150mm X 150mm

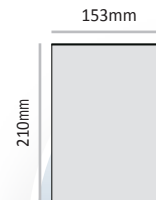

Cat. No.	LE-P-153-210
Unit Height	210 mm
Insert size	150mm X 210mm

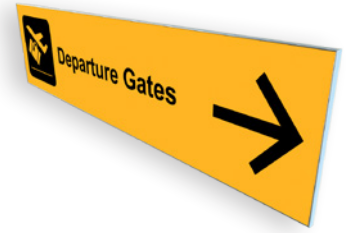

LEF-D-L is the Leader Edge configuration for medium-large sign frames.

The LEF-D-L is the same as the LEF frames but used for larger sign frames as needed in projects to provide a uniform appearance to all sign units.

We offer two configurations of the LEF-D-L to choose from:

DBP - An assembled frame with a thick PVC backer board as a support panel and a composite aluminum sheet as a front panel. Boards are joined together using double-sided self-adhesive tape.

FF - An assembled frame with no faces for use with all other face materials up to 3mm (0.125") thick. This option requires adding a support panel or strips in order to maintain its rigidity.

The LEF-D-L is offered in a wide variety of sizes ranging between 150mm x500mm (6"x20") and 500mm x 1500mm (20" x 60").

Commonly used sizes are presented; however, customized sizes are available upon request.

The installation is very simple. A double-sided self-adhesive tape can be applied to the back of the frame, or concealed screws can be used as well through the built-in channels.



The LEF-D-L is offered with a PVC board attached to the frame as a backer plate to stiffen the frame and also service as base plate for the solid composite aluminum face panel. The face panel is supplied with a self-adhesive at the back ready for self-installation if a drill through wall mount installation is needed.

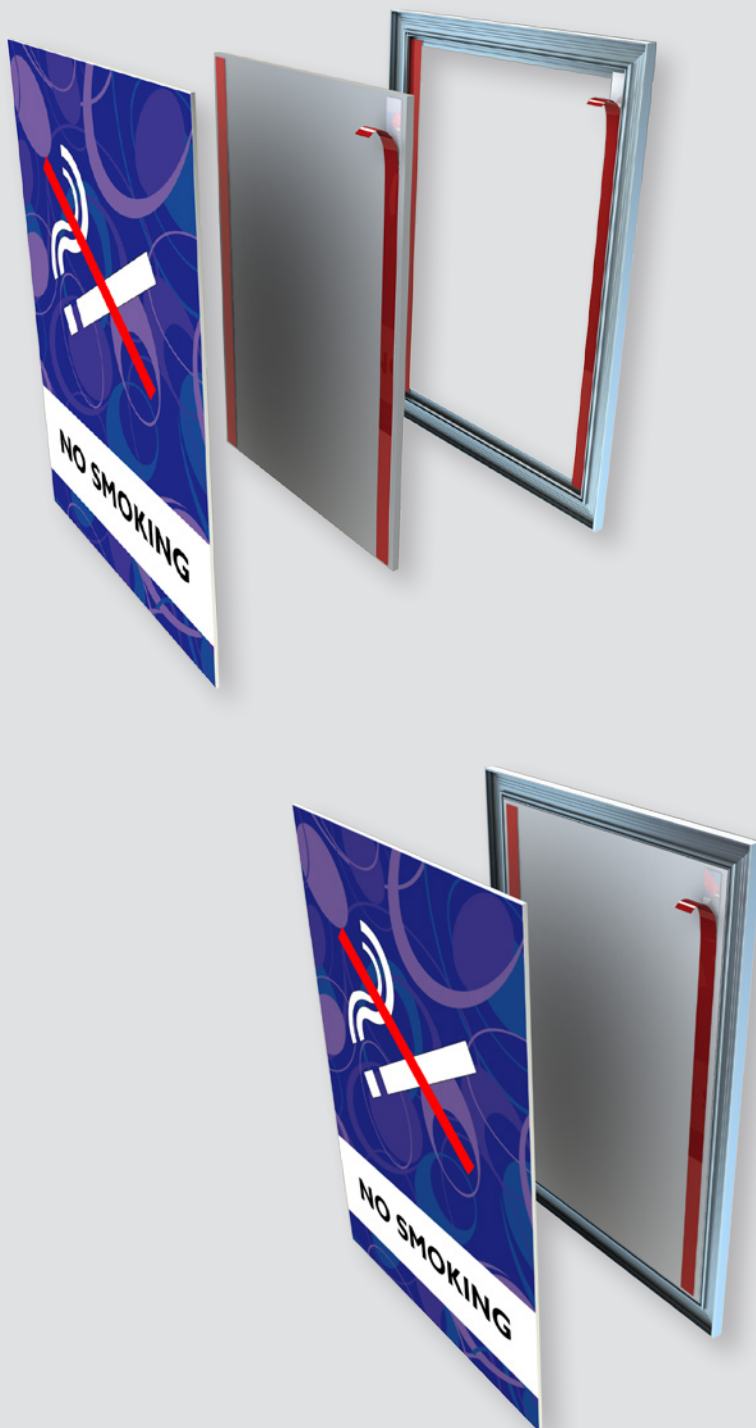

LEF-D-L-H-W

LEF	System Type - Leader Edge Frames
D	Directory
L	Sign layout - Landscape
H	Sign Unit Height - mm
W	Sign Unit Width - mm

LEF-D-L-150

Commonly used unit width (other unit width can be ordered by demand)

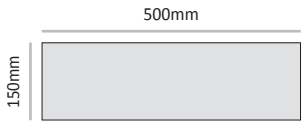

Cat. No. LEF-D-L-150-500
Unit Size HxW 150mm x 500mm

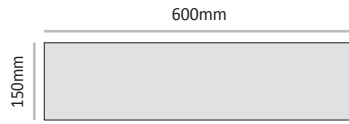

Cat. No. LEF-D-L-150-600
Unit Size HxW 150mm x 600mm

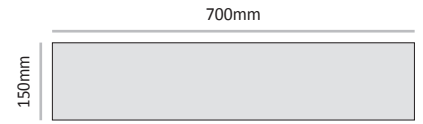

Cat. No. LEF-D-L-150-700
Unit Size HxW 150mm x 700mm



Cat. No. LEF-D-L-150-800
Unit Size HxW 150mm x 800mm



Cat. No. LEF-D-L-150-900
Unit Size HxW 150mm x 900mm



Cat. No. LEF-D-L-150-1000
Unit Size HxW 150mm x 1000mm

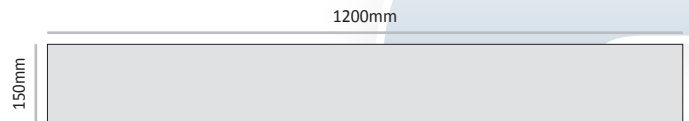

Cat. No. LEF-D-L-150-1200
Unit Size HxW 150mm x 1200mm

LEF-D-L-200

Commonly used unit width (other unit width can be ordered by demand)

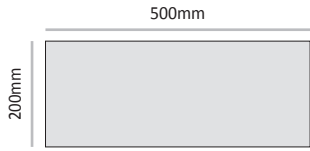

Cat. No. LEF-D-L-200-500
Unit Size HxW 200mm x 500mm

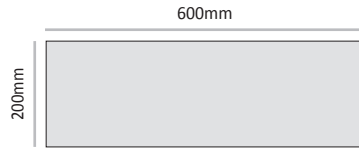

Cat. No. LEF-D-L-200-600
Unit Size HxW 200mm x 600mm

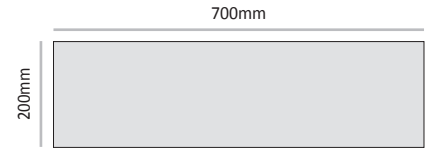

Cat. No. LEF-D-L-200-700
Unit Size HxW 200mm x 700mm

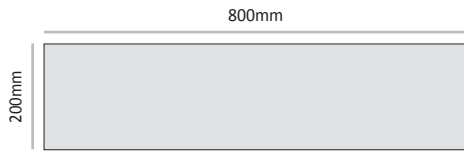

Cat. No. LEF-D-L-200-800
Unit Size HxW 200mm x 800mm

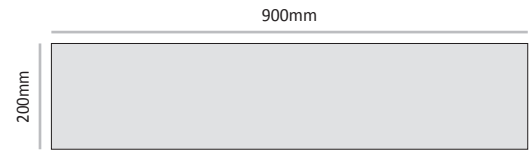

Cat. No. LEF-D-L-200-900
Unit Size HxW 200mm x 900mm



Cat. No. LEF-D-L-200-1000
Unit Size HxW 200mm x 1000mm

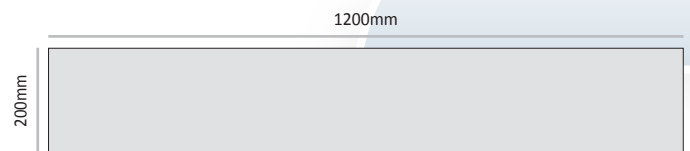

Cat. No. LEF-D-L-200-1200
Unit Size HxW 200mm x 1200mm

LEF-D-L-300

Commonly used unit width (other unit width can be ordered by demand)

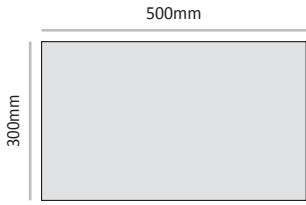

Cat. No. LEF-D-L-300-500
Unit Size HxW 300mm x 500mm

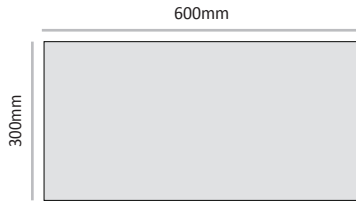

Cat. No. LEF-D-L-300-600
Unit Size HxW 300mm x 600mm

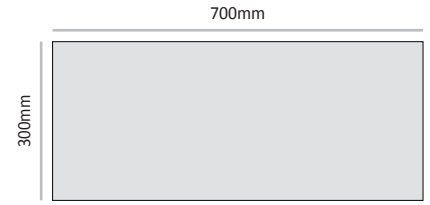

Cat. No. LEF-D-L-300-700
Unit Size HxW 300mm x 700mm

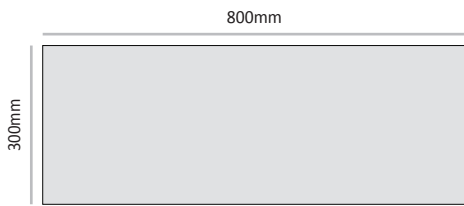

Cat. No. LEF-D-L-300-800
Unit Size HxW 300mm x 800mm

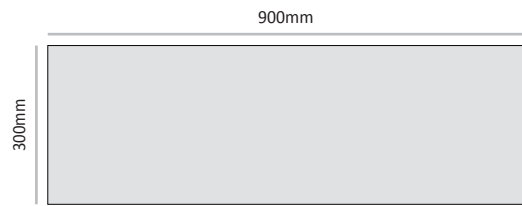

Cat. No. LEF-D-L-300-900
Unit Size HxW 300mm x 900mm



Cat. No. LEF-D-L-300-1000
Unit Size HxW 300mm x 1000mm

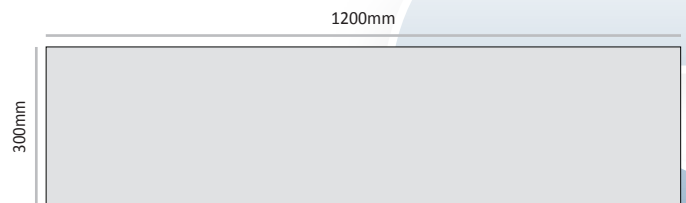

Cat. No. LEF-D-L-300-1200
Unit Size HxW 300mm x 1200mm

LEF-D-L-400

Commonly used unit width (other unit width can be ordered by demand)

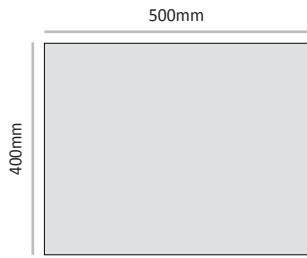

Cat. No.	LEF-D-L-400-500
Unit Size HxW	400mm x 500mm

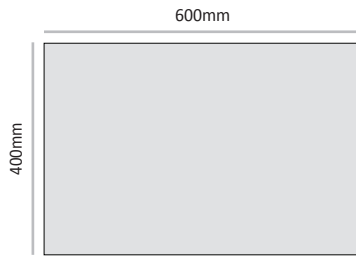

Cat. No.	LEF-D-L-400-600
Unit Size HxW	400mm x 600mm

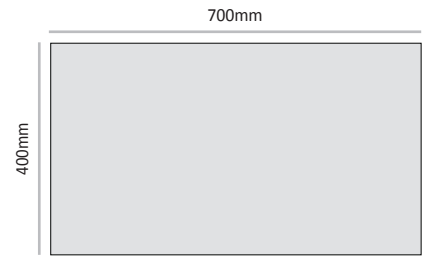

Cat. No.	LEF-D-L-400-700
Unit Size HxW	400mm x 700mm

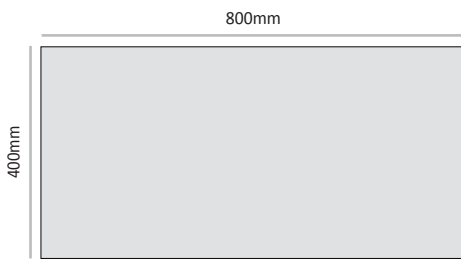

Cat. No.	LEF-D-L-400-800
Unit Size HxW	400mm x 800mm

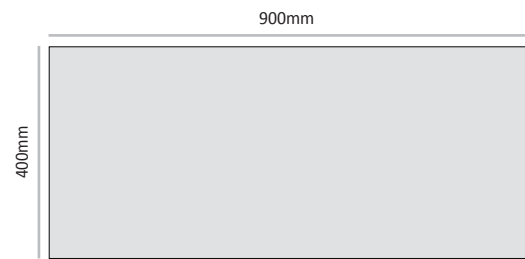

Cat. No.	LEF-D-L-400-900
Unit Size HxW	400mm x 900mm

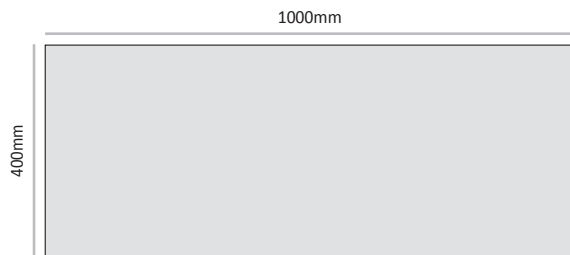

Cat. No.	LEF-D-L-400-1000
Unit Size HxW	400mm x 1000mm

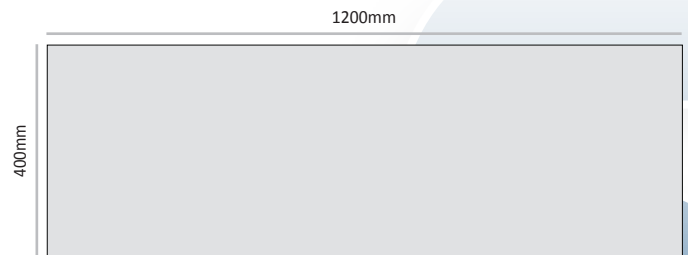

Cat. No.	LEF-D-L-400-1200
Unit Size HxW	400mm x 1200mm

LEF-D-L-500

Commonly used unit width (other unit width can be ordered by demand)

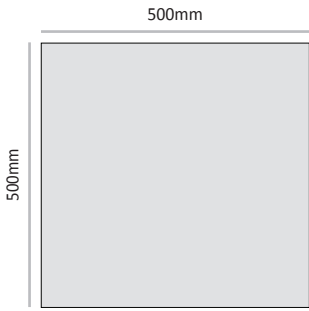

Cat. No. LEF-D-L-500-500
Unit Size HxW 500mm x 500mm

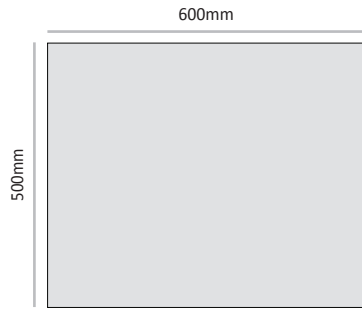

Cat. No. LEF-D-L-500-600
Unit Size HxW 500mm x 600mm

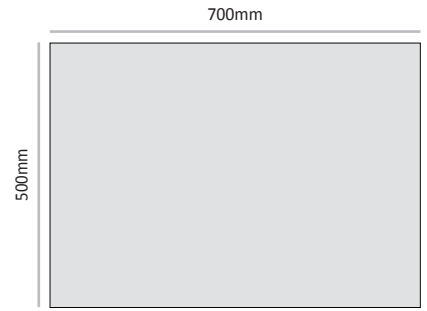

Cat. No. LEF-D-L-500-700
Unit Size HxW 500mm x 700mm

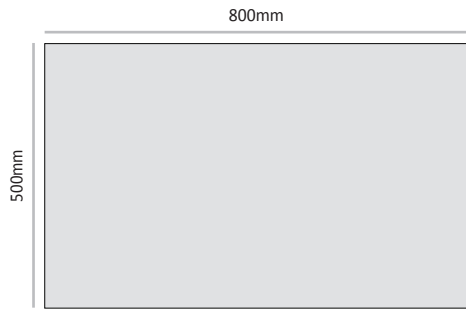

Cat. No. LEF-D-L-500-800
Unit Size HxW 500mm x 800mm

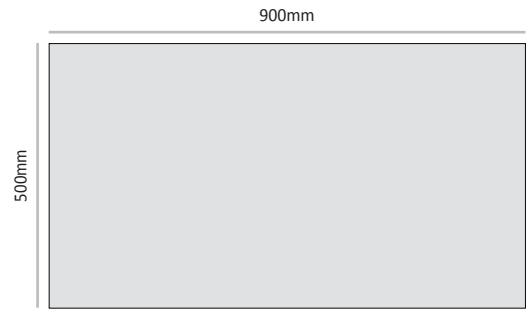

Cat. No. LEF-D-L-500-900
Unit Size HxW 500mm x 900mm

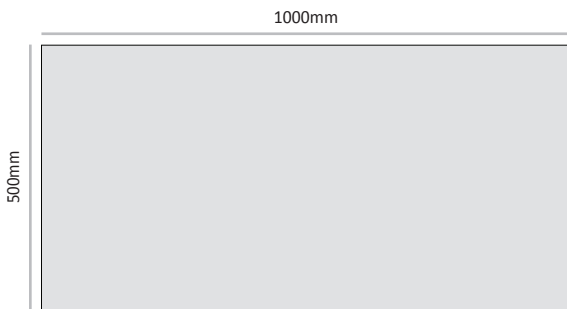

Cat. No. LEF-D-L-500-1000
Unit Size HxW 500mm x 1000mm



Cat. No. LEF-D-L-500-1200
Unit Size HxW 500mm x 1200mm



LEF-D-P is the Leader Edge configuration for directory sign frames.

Strips arrayed in unlimited combinations create a unique, thin, and elegant directory sign.

The LEF-D-P is offered with silver anodized strips cut as requested to your specifications, placed over a back panel covered with a thin metal sheet using self-adhesive magnet strips.

Strips are easy to insert and remove using our silicone suction cup.

Five standard frame widths are offered: 300, 400, 500, 600 and 700mm (11", 16", 20", 24" and 28") in endless height options.

Commonly used sizes are presented; however, customized sizes are available upon request.

The installation is very simple. A double-sided self-adhesive tape can be applied to the back of the frame, or concealed screws can be used as well through the built-in channels.

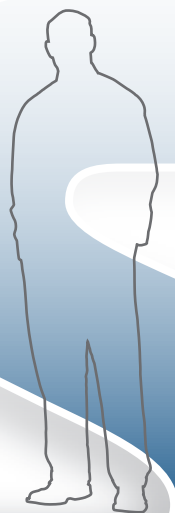
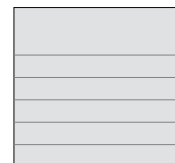

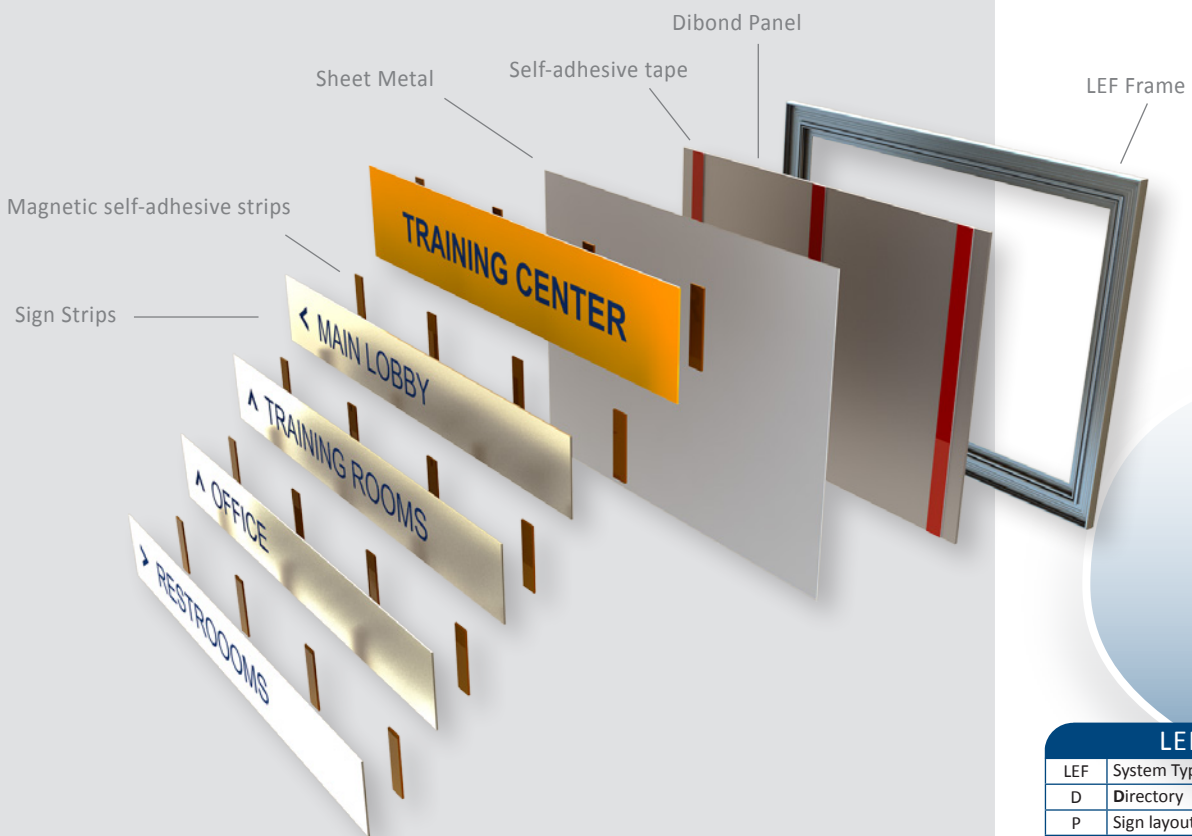
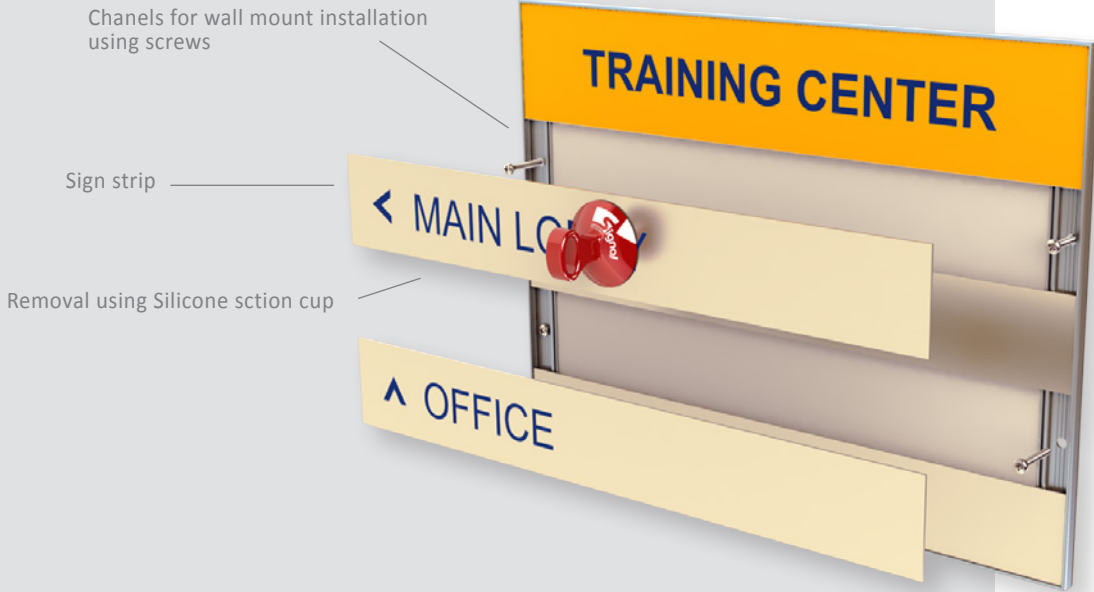

LEF-D-P-W-H	
LEF	System Type - Leader Edge Frames
D	Directory
P	Sign layout - Portrait
W	Sign Unit Width - mm
H	Sign Unit Height - mm

LEF-D-P-300

Commonly used unit height (other unit height can be ordered by demand)

The number and measures of the strips can be ordered by demand.

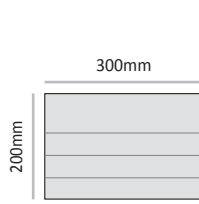

Cat. No. LEF-D-P-300-200
Unit Size WxH 300mm x 200mm

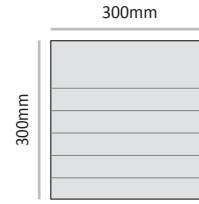

Cat. No. LEF-D-P-300-300
Unit Size WxH 300mm x 300mm

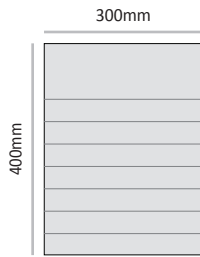

Cat. No. LEF-D-P-300-400
Unit Size WxH 300mm x 400mm

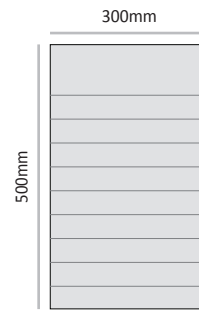

Cat. No. LEF-D-P-300-500
Unit Size WxH 300mm x 500mm

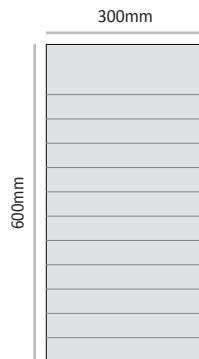

Cat. No. LEF-D-P-300-600
Unit Size WxH 300mm x 600mm

LEF-D-P-400

Commonly used unit height (other unit height can be ordered by demand)

The number and measures of the strips can be ordered by demand.

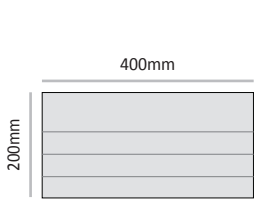

Cat. No. LEF-D-P-400-200
Unit Size WxH 400mm x 200mm

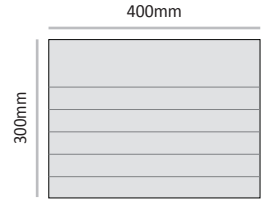

Cat. No. LEF-D-P-400-300
Unit Size WxH 400mm x 300mm

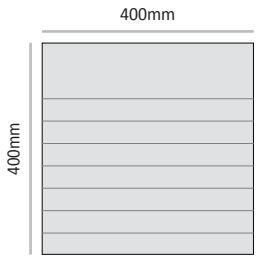

Cat. No. LEF-D-P-400-400
Unit Size WxH 400mm x 400mm

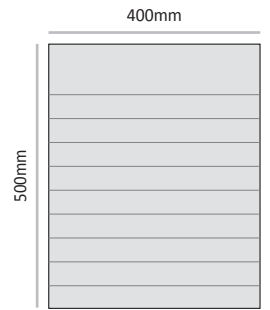

Cat. No. LEF-D-P-400-500
Unit Size WxH 400mm x 500mm

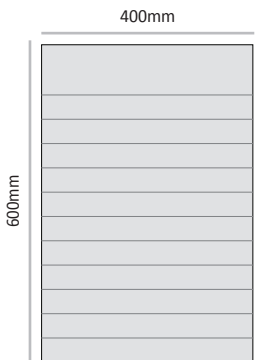

Cat. No. LEF-D-P-400-600
Unit Size WxH 400mm x 600mm

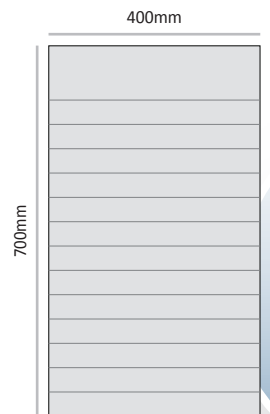

Cat. No. LEF-D-P-400-700
Unit Size WxH 400mm x 700mm

LEF-D-P-500

Commonly used unit height (other unit height can be ordered by demand)

The number and measures of the strips can be ordered by demand.

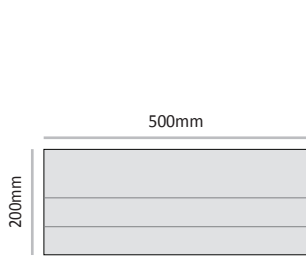

Cat. No. LEF-D-P-500-200
Unit Size WxH 500mm x 200mm

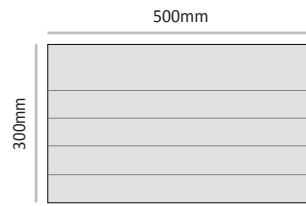

Cat. No. LEF-D-P-500-300
Unit Size WxH 500mm x 300mm

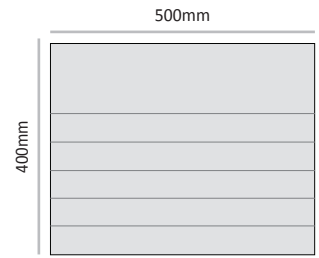

Cat. No. LEF-D-P-500-400
Unit Size WxH 500mm x 400mm

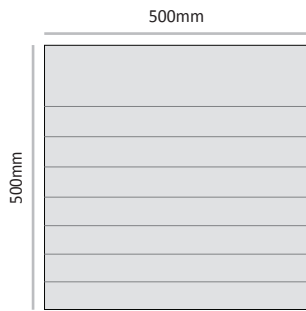

Cat. No. LEF-D-P-500-500
Unit Size WxH 500mm x 500mm

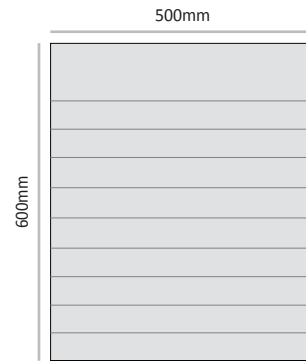

Cat. No. LEF-D-P-500-600
Unit Size WxH 500mm x 600mm

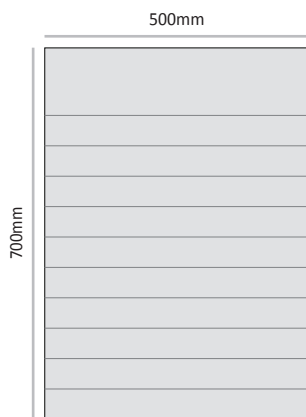

Cat. No. LEF-D-P-500-700
Unit Size WxH 500mm x 700mm

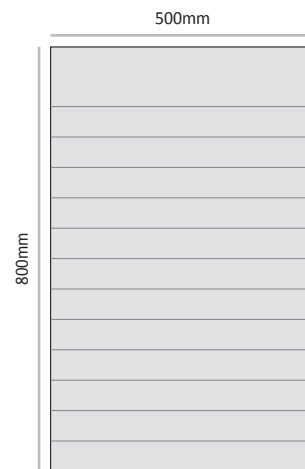

Cat. No. LEF-D-P-500-800
Unit Size WxH 500mm x 800mm

LEF-D-P-600

Commonly used unit height (other unit height can be ordered by demand)

The number and measures of the strips can be ordered by demand.

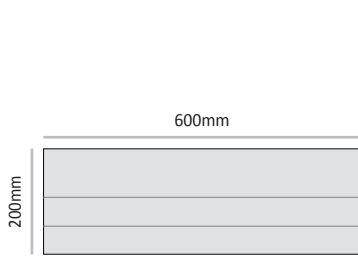

Cat. No. LEF-D-P-600-200
Unit Size WxH 600mm x 200mm

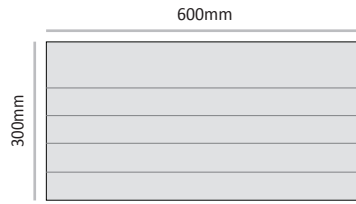

Cat. No. LEF-D-P-600-300
Unit Size WxH 600mm x 300mm

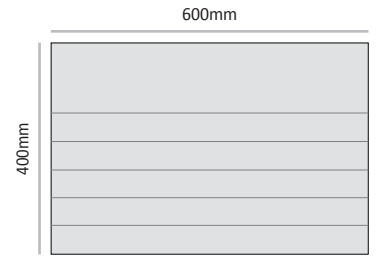

Cat. No. LEF-D-P-600-400
Unit Size WxH 600mm x 400mm

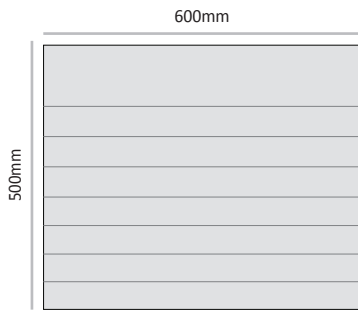

Cat. No. LEF-D-P-600-500
Unit Size WxH 600mm x 500mm

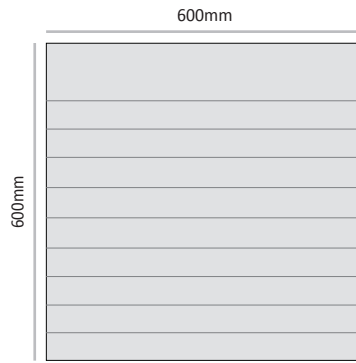

Cat. No. LEF-D-P-600-600
Unit Size WxH 600mm x 600mm

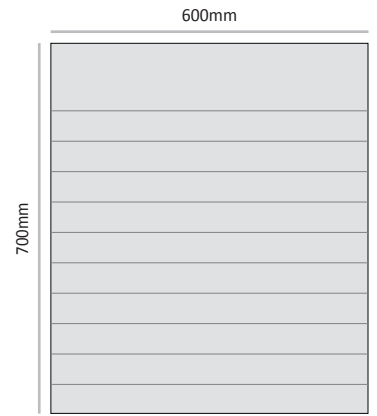

Cat. No. LEF-D-P-600-700
Unit Size WxH 600mm x 700mm

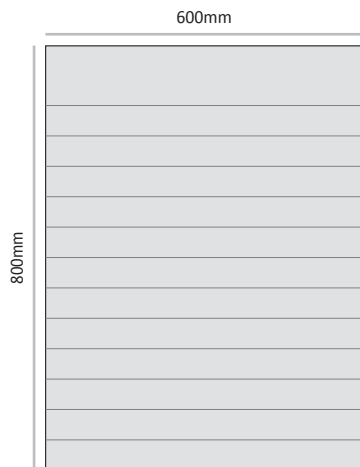

Cat. No. LEF-D-P-600-800
Unit Size WxH 600mm x 800mm

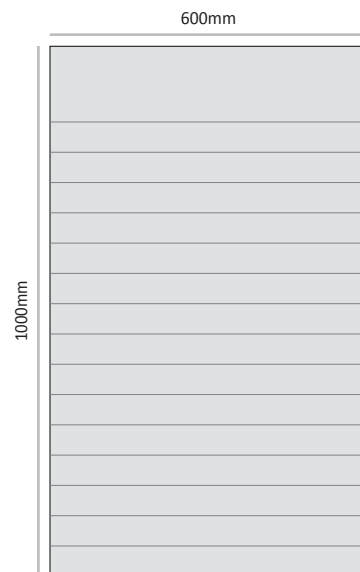

Cat. No. LEF-D-P-600-1000
Unit Size WxH 600mm x 1000mm

LEF-D-P-700

Commonly used unit height (other unit height can be ordered by demand)

The number and measures of the strips can be ordered by demand.

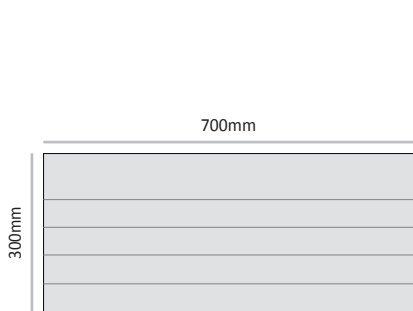

Cat. No. LEF-D-P-700-300
Unit Size WxH 700mm x 300mm



Cat. No. LEF-D-P-700-400
Unit Size WxH 700mm x 400mm



Cat. No. LEF-D-P-700-500
Unit Size WxH 700mm x 500mm

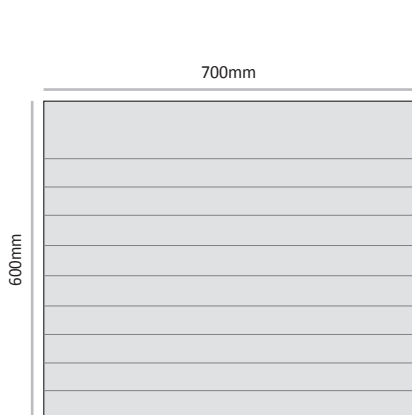

Cat. No. LEF-D-P-700-600
Unit Size WxH 700mm x 600mm

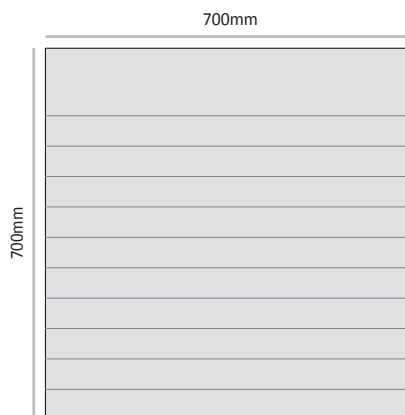

Cat. No. LEF-D-P-700-700
Unit Size WxH 700mm x 700mm

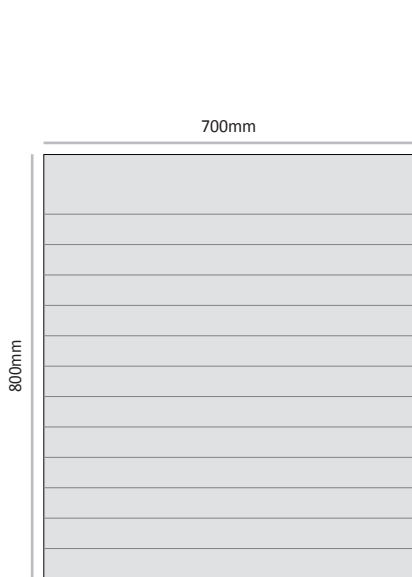

Cat. No. LEF-D-P-700-800
Unit Size WxH 700mm x 800mm



Cat. No. LEF-D-P-700-1000
Unit Size WxH 700mm x 1000mm



LE-DS-L is a double-sided suspended sign frame in a landscape configuration.

The LE-DS-L is an economy version using the LE-L offered in three height options: 55, 107 and 153mm (2", 4", 6") or as a perimeter frame using LEF frames in different sizes ranging between 75mm and 300mm (3" to 12").

Commonly used width options are presented; however, customized widths are available upon request.

The installation can be done by using our chrome plated auto lock adjustable cable grip ceiling anchors.

For sign frames with heights ranging between 55mm and 153mm (2" to 6") using the LE-L solid profiles, vinyl graphics can be applied directly on the profile's smooth flat face or printed paper with a clear lens cover.

For signs that use the LEF perimeter frames we offer two face options:

CC - A double-layer face: A lightweight thin opaque PVC sheet is used as a basic support face along with a clear polycarbonate cover lens.

DBP - A single layer face: A solid Dibond® composite aluminum board is fixed in frame, ready for direct application of vinyl graphics.

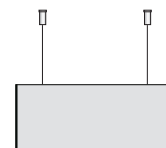

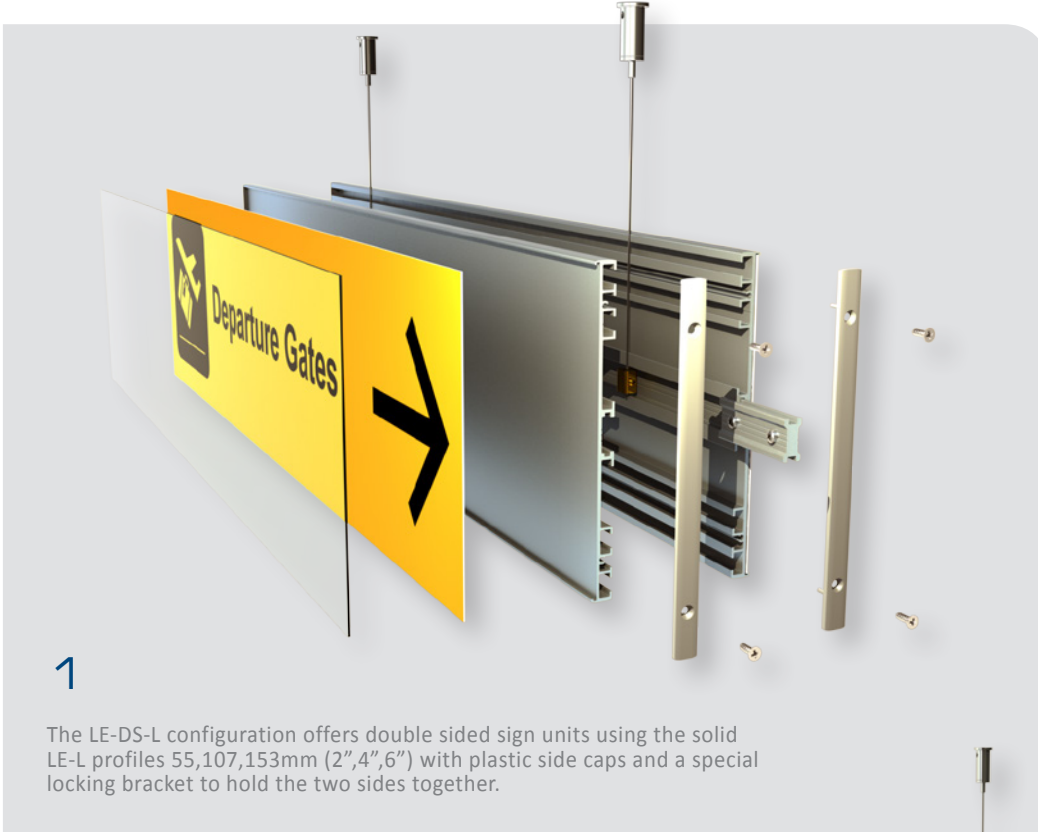

LE-DS-L-H-W-EC	
LE	System Type - Leader Edge
DS	Double Sided
L	Sign layout - Landscape
H	Sign Unit Height - mm
W	Sign Unit Width - mm
EC	End caps finish GR - Grey BK - Black CR - Chrome Plated

LE-DS-L-55

Commonly used unit width (other unit width can be ordered by demand)

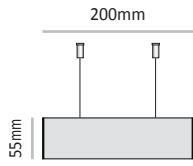

Cat. No.	LE-DS-L-55-200
Unit Width	200 mm
Insert size	52mm X 200mm

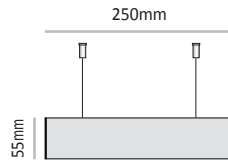

Cat. No.	LE-DS-L-55-250
Unit Width	250 mm
Insert size	52mm X 250mm

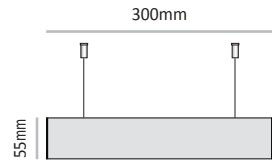

Cat. No.	LE-DS-L-55-300
Unit Width	300 mm
Insert size	52mm X 300mm

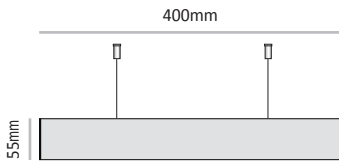

Cat. No.	LE-DS-L-55-400
Unit Width	400 mm
Insert size	52mm X 400mm

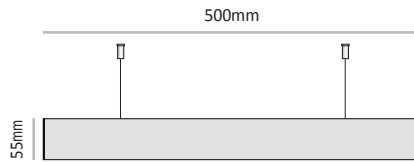

Cat. No.	LE-DS-L-55-500
Unit Width	500 mm
Insert size	52mm X 500mm

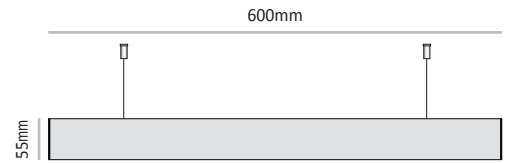

Cat. No.	LE-DS-L-55-600
Unit Width	600 mm
Insert size	52mm X 600mm

LE-DS-L-107

Commonly used unit width (other unit width can be ordered by demand)

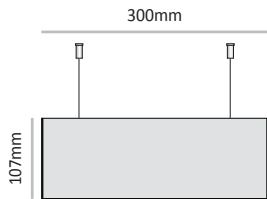

Cat. No.	LE-DS-L-107-300
Unit Width	300 mm
Insert size	105mm X 300mm

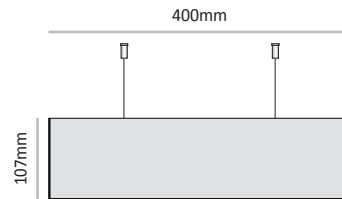

Cat. No.	LE-DS-L-107-400
Unit Width	400 mm
Insert size	105mm X 400mm

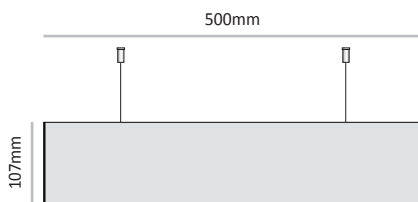

Cat. No.	LE-DS-L-107-500
Unit Width	500 mm
Insert size	105mm X 500mm



Cat. No.	LE-DS-L-107-600
Unit Width	600 mm
Insert size	105mm X 600mm

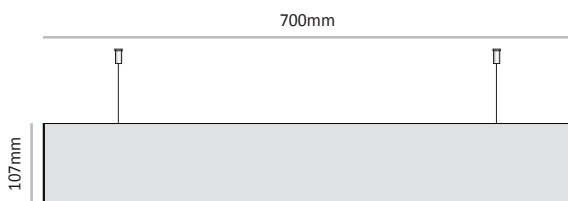

Cat. No.	LE-DS-L-107-700
Unit Width	700 mm
Insert size	105mm X 700mm

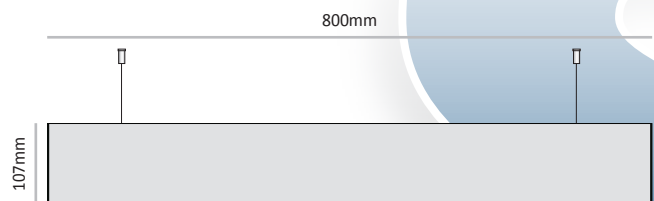

Cat. No.	LE-DS-L-107-800
Unit Width	800 mm
Insert size	105mm X 800mm

LE-DS-L-153

Commonly used unit width (other unit width can be ordered by demand)

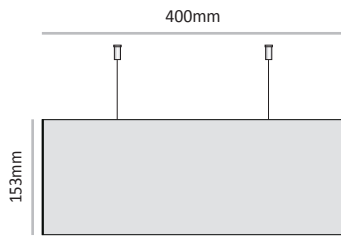

Cat. No.	LE-DS-L-153-400
Unit Width	400 mm
Insert size	150mm X 400mm

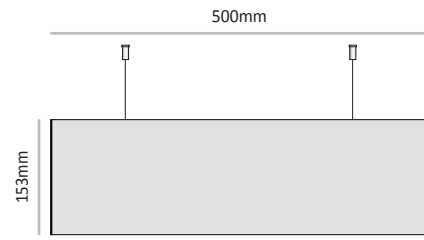

Cat. No.	LE-DS-L-153-500
Unit Width	500 mm
Insert size	150mm X 500mm

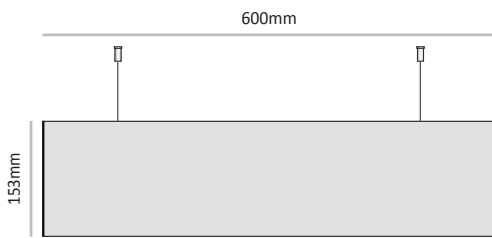

Cat. No.	LE-DS-L-153-600
Unit Width	600 mm
Insert size	150mm X 600mm

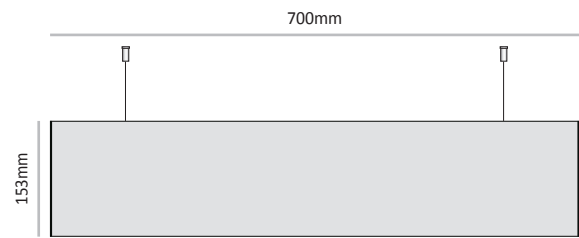

Cat. No.	LE-DS-L-153-700
Unit Width	700 mm
Insert size	150mm X 700mm

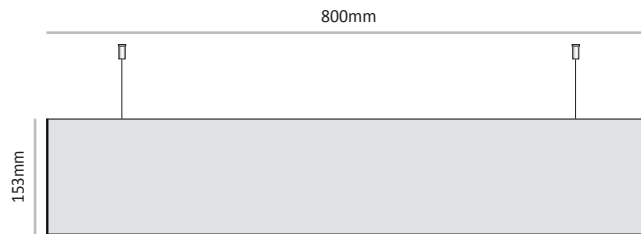

Cat. No.	LE-DS-L-153-800
Unit Width	800 mm
Insert size	150mm X 800mm

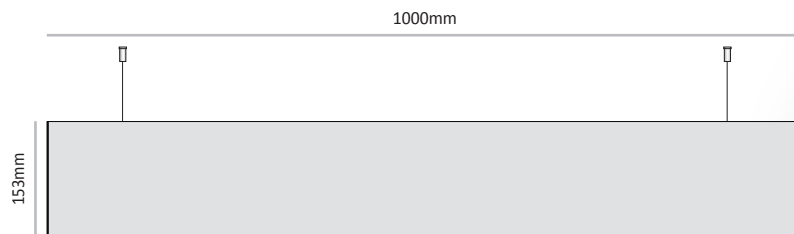

Cat. No.	LE-DS-L-153-1000
Unit Width	1000 mm
Insert size	150mm X 1000mm

LEF-DS-L-210

Commonly used unit width (other unit width can be ordered by demand)

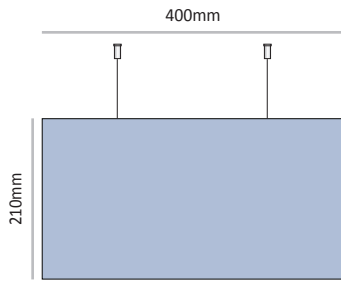

Cat. No. LEF-DS-L-210-400
Unit Size HxW 210mm x 400mm

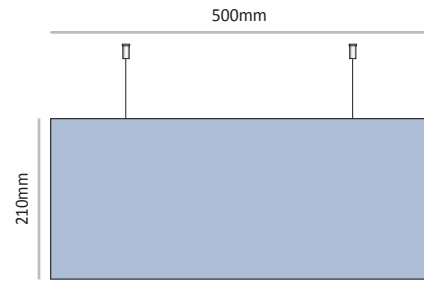

Cat. No. LEF-DS-L-210-500
Unit Size HxW 210mm x 500mm

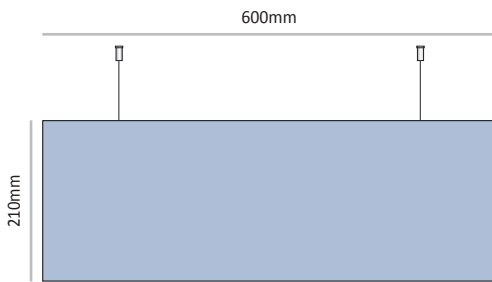

Cat. No. LEF-DS-L-210-600
Unit Size HxW 210mm x 600mm

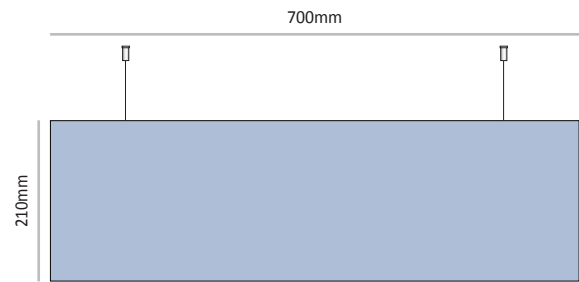

Cat. No. LEF-DS-L-210-700
Unit Size HxW 210mm x 700mm

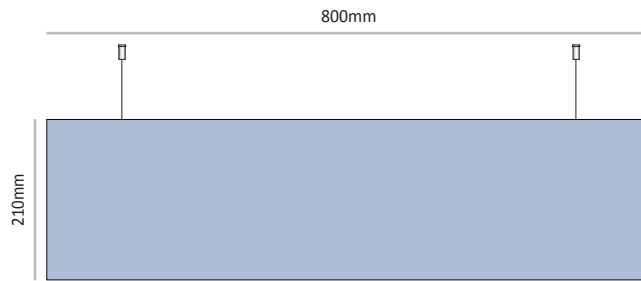

Cat. No. LEF-DS-L-210-800
Unit Size HxW 210mm x 800mm

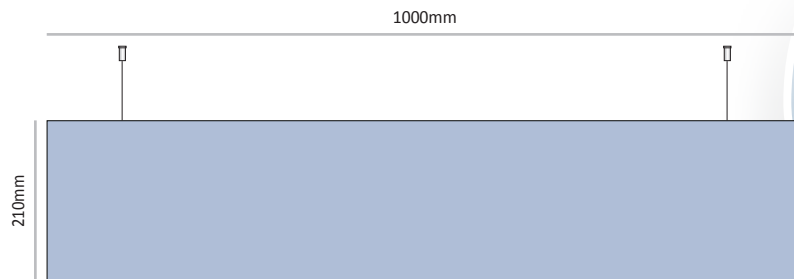

Cat. No. LEF-DS-L-210-1000
Unit Size HxW 210mm x 1000mm

LEF-DS-L-300

Commonly used unit width (other unit width can be ordered by demand)

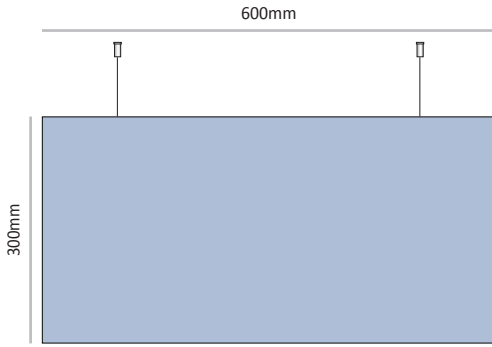

Cat. No. LEF-DS-L-300-600
Unit Size HxW 300mm x 600mm

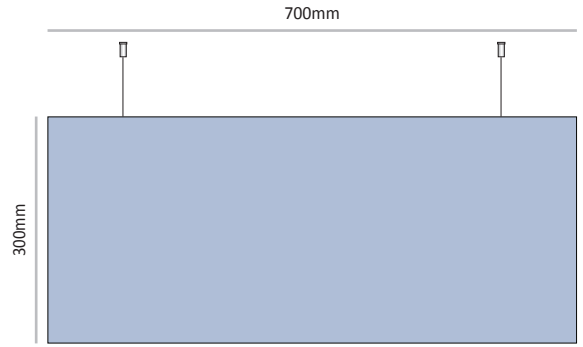

Cat. No. LEF-DS-L-300-700
Unit Size HxW 300mm x 700mm

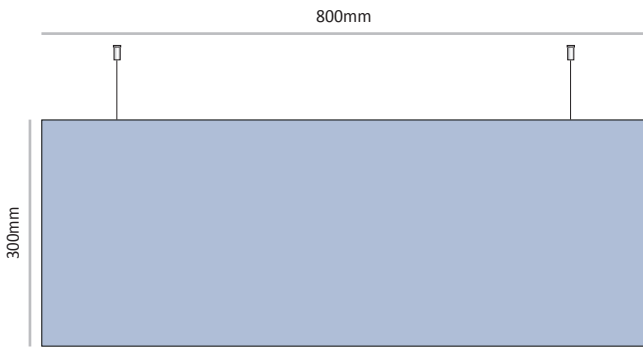

Cat. No. LEF-DS-L-300-800
Unit Size HxW 300mm x 800mm

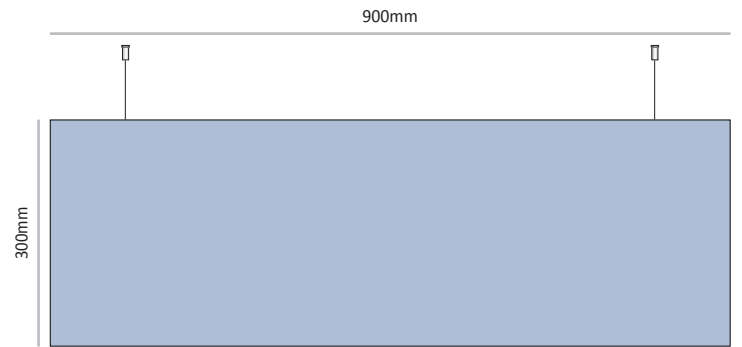

Cat. No. LEF-DS-L-300-900
Unit Size HxW 300mm x 900mm

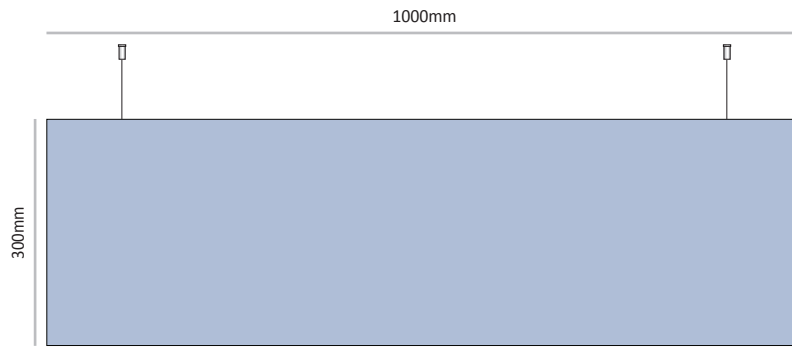

Cat. No. LEF-DS-L-300-1000
Unit Size HxW 300mm x 1000mm

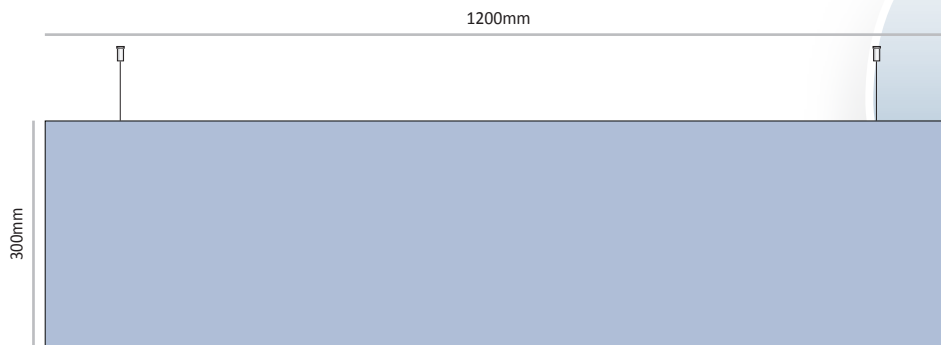

Cat. No. LEF-DS-L-300-1200
Unit Size HxW 300mm x 1200mm



LEF-D-DS-P is a double-sided suspended directory sign frame in a portrait configuration.

The LEF-DS-D-P comes with silver anodized strips cut as requested to your specifications, placed on top of a back panel that is covered with a thin metal sheet using self-adhesive magnet strips.

Strips are easy to insert and remove using our silicone suction cup.

Three standard frame widths are offered: 400, 500 and 600mm (16", 20" and 24") in limitless height options.

Commonly used size options are presented; however, customized sizes are available upon request.

The installation can be done by using our chrome plated auto lock adjustable cable grip ceiling anchors.

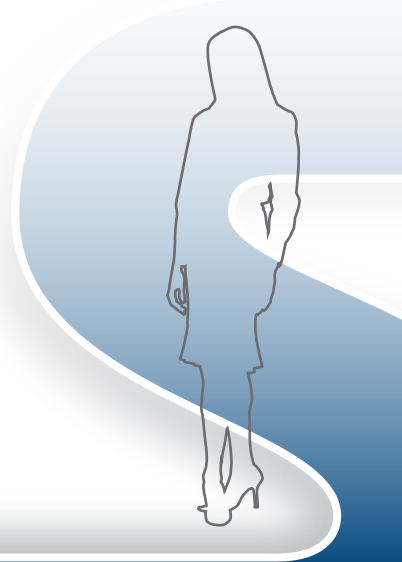
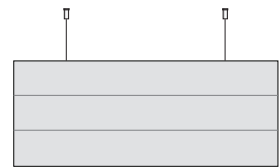



Installation can be done by using chrome plated auto lock cable grip ceiling anchors and PVC coated steel cable.

LEF-D-DS-P-W-H	
LEF	System Type - Leader Edge Frames
D	Directory
DS	Double Sided
P	Sign layout - Portarit
W	Sign Unit Width - mm
H	Sign Unit Height - mm

LEF-D-DS-P-400

Commonly used unit height (other unit height can be ordered by demand)

The number and measures of the strips can be ordered by demand.

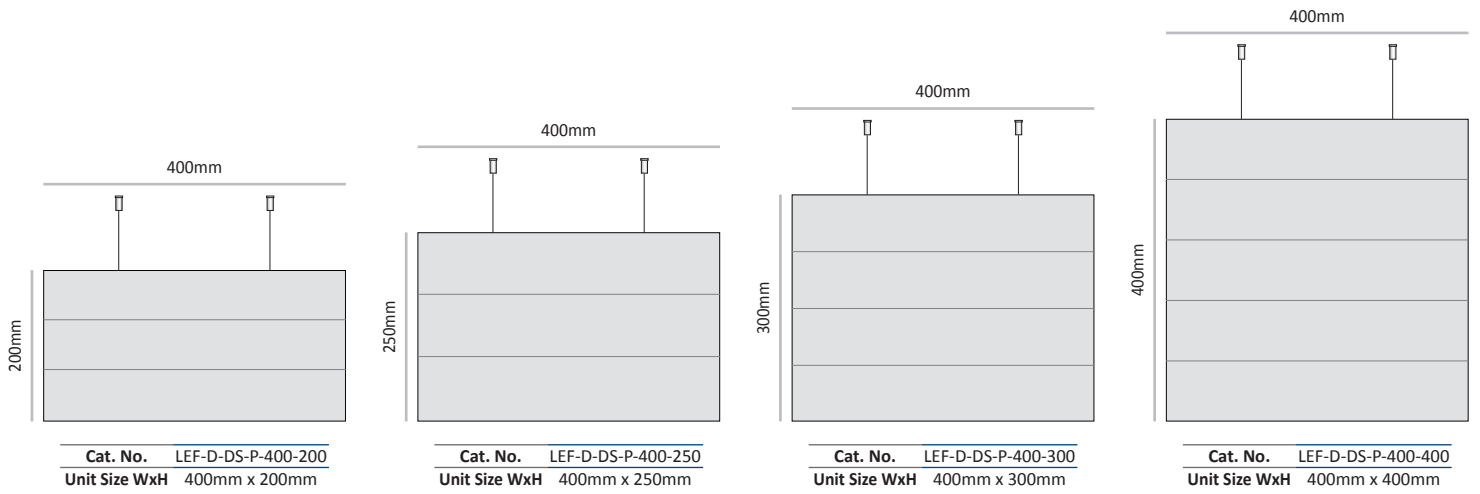

LEF-D-DS-P-500

Commonly used unit height (other unit height can be ordered by demand)

The number and measures of the strips can be ordered by demand.

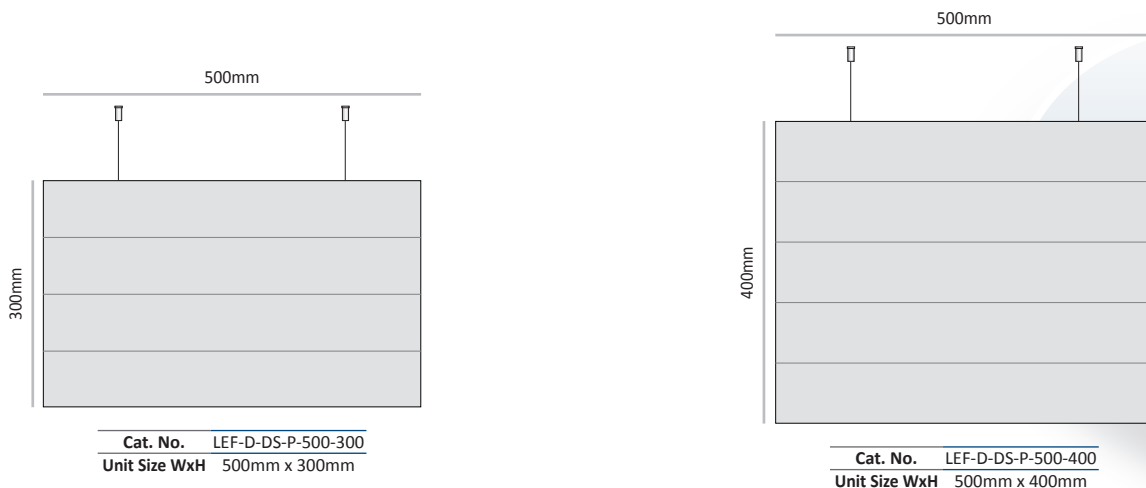
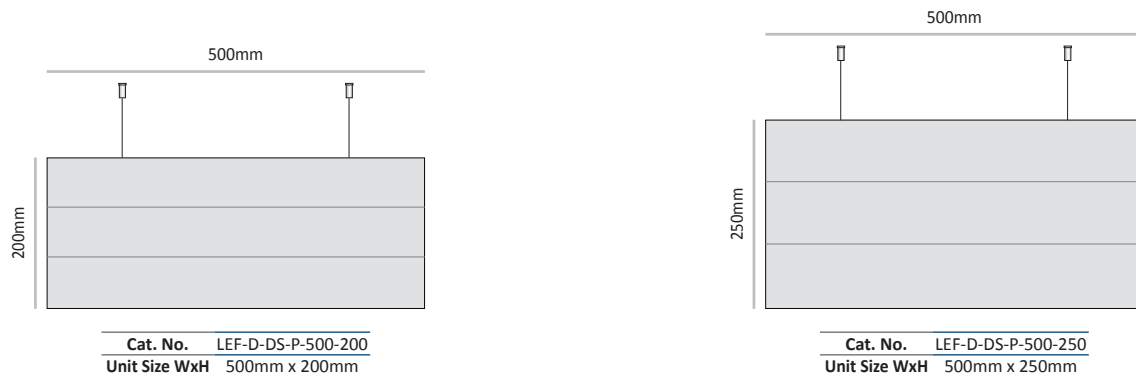

LEF-D-DS-P-600

Commonly used unit height (other unit height can be ordered by demand)

The number and measures of the strips can be ordered by demand.

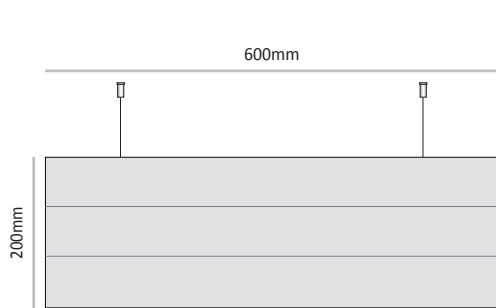

Cat. No. LEF-D-DS-P-600-200
Unit Size WxH 600mm x 200mm

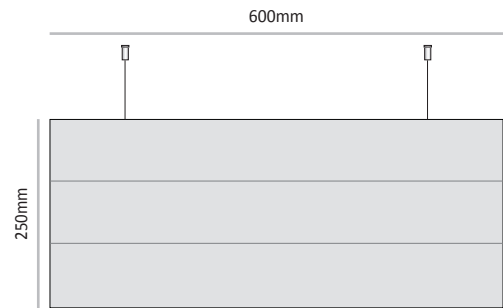

Cat. No. LEF-D-DS-P-600-250
Unit Size WxH 600mm x 250mm

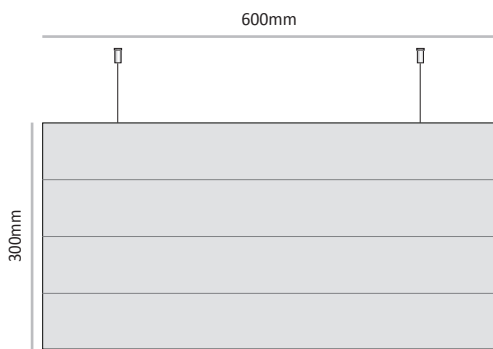

Cat. No. LEF-D-DS-P-600-300
Unit Size WxH 600mm x 300mm

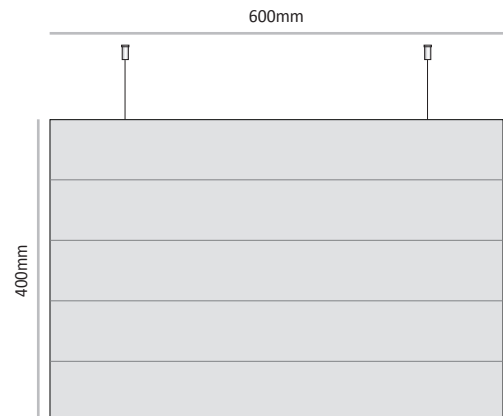

Cat. No. LEF-D-DS-P-600-400
Unit Size WxH 600mm x 400mm



LEPF-L is a projecting flag sign in a landscape configuration.

This elegant yet simple double-sided projecting flag sign is created by attaching two Leader Edge profiles back to back, bolted to a rectangular anodized aluminum base plate.

The LEPF-L is available in five heights: 105, 125, 150, 210 and 300mm (4", 5", 6", 8.5", 11") in many length options.

The LEPF-L is an economy version that uses the LE-L 107 and 153mm solid profiles.

All other sizes use the LEF configuration without the plastic end caps.

All presented length options are commonly used sizes; however, customized lengths are available upon request.

The smooth face of the Leader Edge economy profiles is great for direct vinyl graphics application or printed paper inserts as well.

Changing the paper insert is simple and easy using our silicone suction cup.





1

The LEPPF-L configuration is using the LE-L solid profiles and plastic side caps with two standard height options 107,153mm (4", 6").



2

An easy insert removal using our silicone suction cup



3

Plastic end caps are available in three finishes to choose from: Grey ABS, Black ABS and Chrome plated ABS.

LEPPF-L-H-W-EC

LE	System Type - Leader Edge
PF	Projecting Flags
L	Sign layout - Landscape
H	Sign Unit Height - mm
W	Sign Unit Width - mm
EC	End caps finish GR - Grey BK - Black CR - Chrome Plated



4

The LEF-PF-L offers five standard units height: 105, 125, 150, 210 and 300mm (4", 5", 6", 8.5" and 11") using the LEF perimeter frame on 3 sides either with a paper insert or with a composite aluminum board as faces.

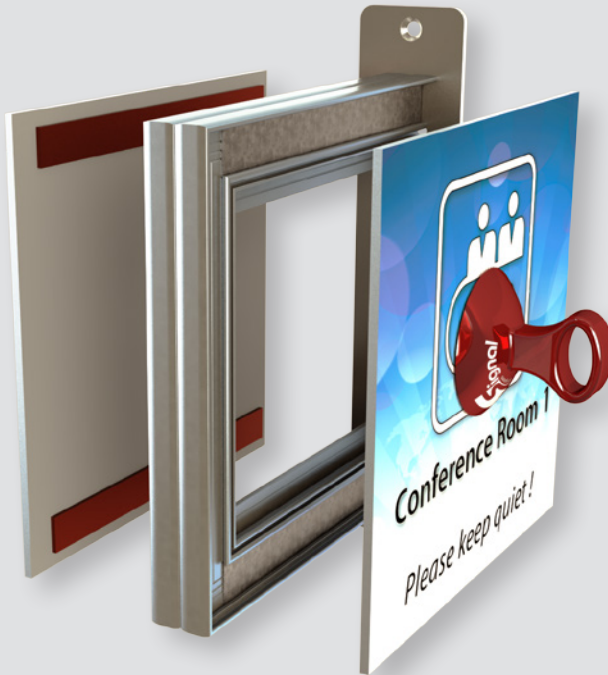

5

An LEF-PF-L unit with removable composite aluminum board faces using magnetic ribbons.

LEPF-L-107

Commonly used unit width (other unit width can be ordered by demand)

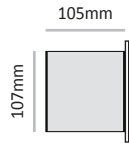

Cat. No.	LEPF-L-107-105
Unit Width	105 mm
Insert size	105mm X 105mm

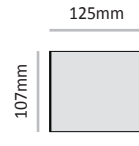

Cat. No.	LEPF-L-107-125
Unit Width	125 mm
Insert size	105mm X 125mm

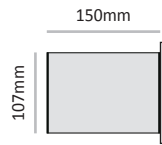

Cat. No.	LEPF-L-107-150
Unit Width	150 mm
Insert size	105mm X 150mm

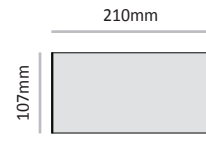

Cat. No.	LEPF-L-107-210
Unit Width	210 mm
Insert size	105mm X 210mm

LEPF-L-153

Commonly used unit width (other unit width can be ordered by demand)

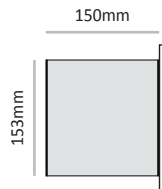

Cat. No.	LEPF-L-153-150
Unit Width	150 mm
Insert size	150mm X 150mm

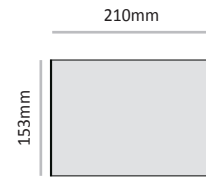

Cat. No.	LEPF-L-153-210
Unit Width	210 mm
Insert size	150mm X 210mm

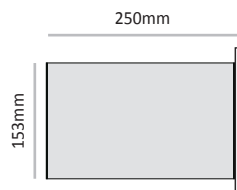

Cat. No.	LEPF-L-153-250
Unit Width	250 mm
Insert size	150mm X 250mm

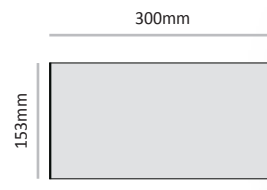

Cat. No.	LEPF-L-153-300
Unit Width	300 mm
Insert size	150mm X 300mm

LEFPF-L-105

Commonly used unit width (other unit width can be ordered by demand)

Paper Insert Size = Overall - 3mm
Hard Panel Face Size = Overall - 4mm

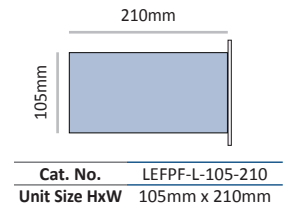
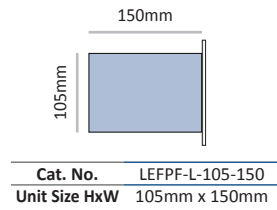
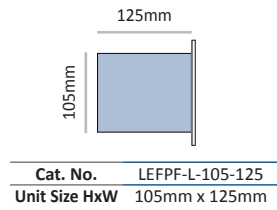
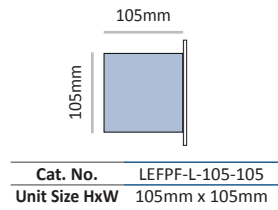

LEFPF-L-125

Commonly used unit width (other unit width can be ordered by demand)

Paper Insert Size = Overall - 3mm
Hard Panel Face Size = Overall - 4mm

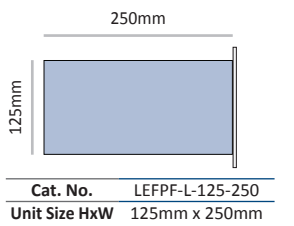
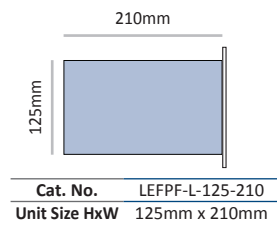
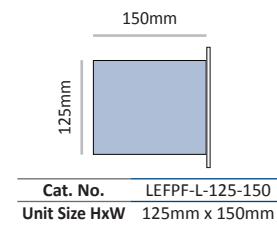
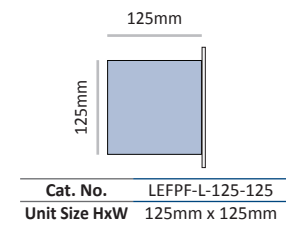

LEFPF-L-150

Commonly used unit width (other unit width can be ordered by demand)

Paper Insert Size = Overall - 3mm
Hard Panel Face Size = Overall - 4mm

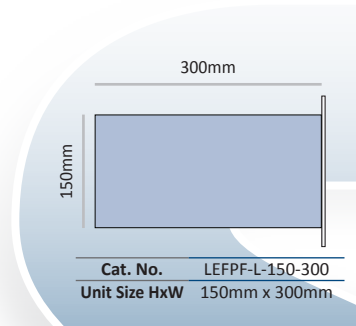
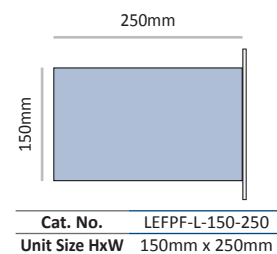
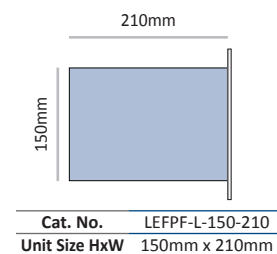
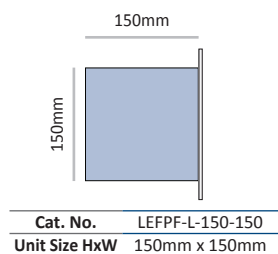

LEFPF-L-210

Commonly used unit width (other unit width can be ordered by demand)

Paper Insert Size = Overall - 3mm
Hard Panel Face Size = Overall - 4mm

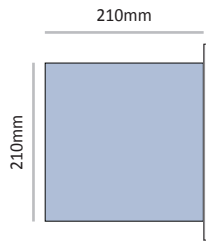

Cat. No. LEFPF-L-210-210
Unit Size HxW 210mm x 210mm

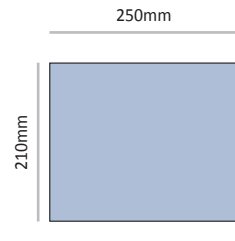

Cat. No. LEFPF-L-210-250
Unit Size HxW 210mm x 250mm

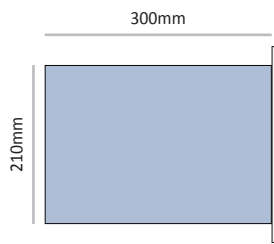

Cat. No. LEFPF-L-210-300
Unit Size HxW 210mm x 300mm

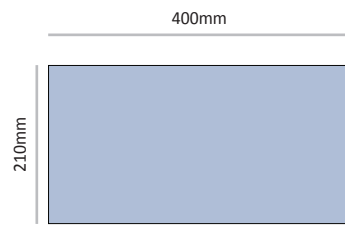

Cat. No. LEFPF-L-210-400
Unit Size HxW 210mm x 400mm

LEFPF-L-300

Commonly used unit width (other unit width can be ordered by demand)

Paper Insert Size = Overall - 3mm
Hard Panel Face Size = Overall - 4mm

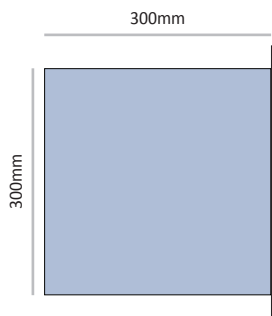

Cat. No. LEFPF-L-300-300
Unit Size HxW 300mm x 300mm

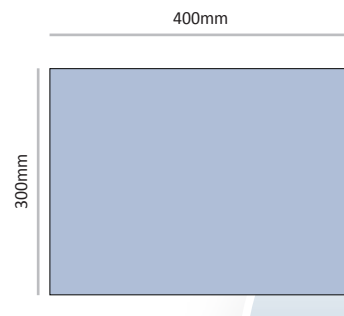

Cat. No. LEFPF-L-300-400
Unit Size HxW 300mm x 400mm

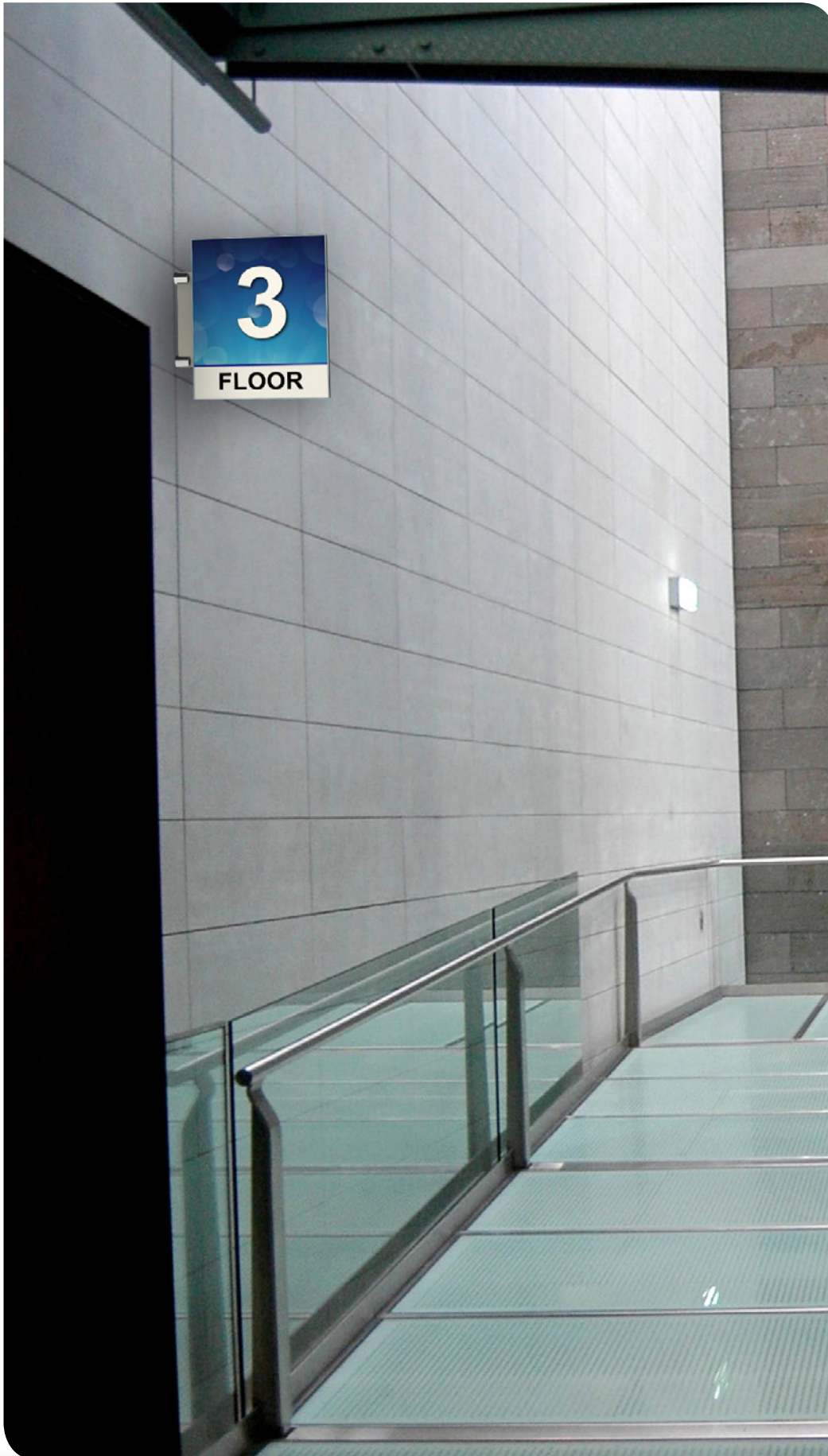

LEPPF-P is a projecting flag sign in a portrait configuration.

A unique elegant double-sided projecting flag sign is created by attaching two Leader Edge frames back to back, bolted to a center anodized aluminum plate support and installed using two round chrome plated anchoring spacers.

The LEPPF-P is available in five widths: 105, 125, 150, 210 and 300mm, in many height options.

The LEPPF-P is offered as an economy version using the LE-P 107mm and 153mm solid profiles. All other sizes use the LEF configuration without the plastic end caps.

Commonly used size options are presented; however, customized sizes are available upon request.

The smooth face of the Leader Edge economy profiles is great for direct vinyl graphics application or printed paper inserts as well.

Changing the paper insert is simple and easy using our silicone suction cup.

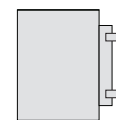



1

The LEF-PF-P offers five standard units width: 105, 125, 150, 210 and 300mm (4", 5", 6", 8.5" and 11") using the LEF perimeter frame units either with a paper insert or with a composite aluminum board as faces.

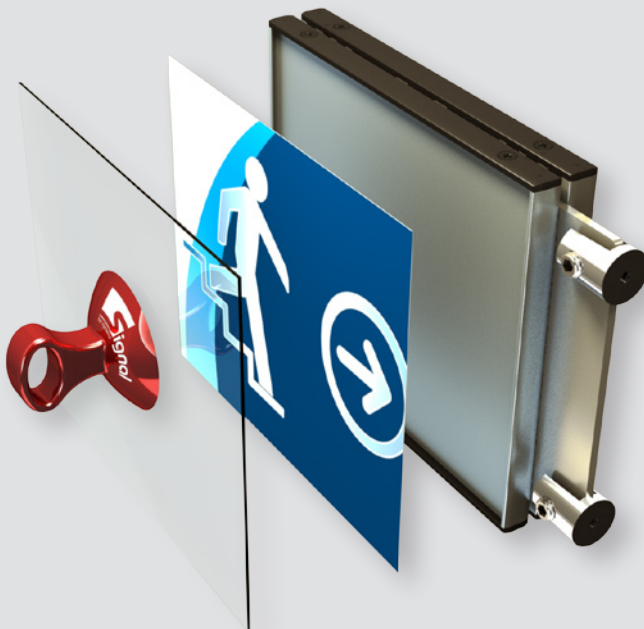

2

The LEFP-P offers two standard units width 107 and 153mm using the solid LE-P profiles with top and bottom plastic end caps. A paper insert with a clear polycarbonate lens cover is recommended with this configuration.

LEFPF-P-H-W-EC

LEF	System Type - Leader Edge Frames
PF	Projecting Flags
P	Sign layout - Portrait
H	Sign Unit Height - mm
W	Sign Unit Width - mm
EC	End caps finish GR - Grey BK - Black CR - Chrome Plated

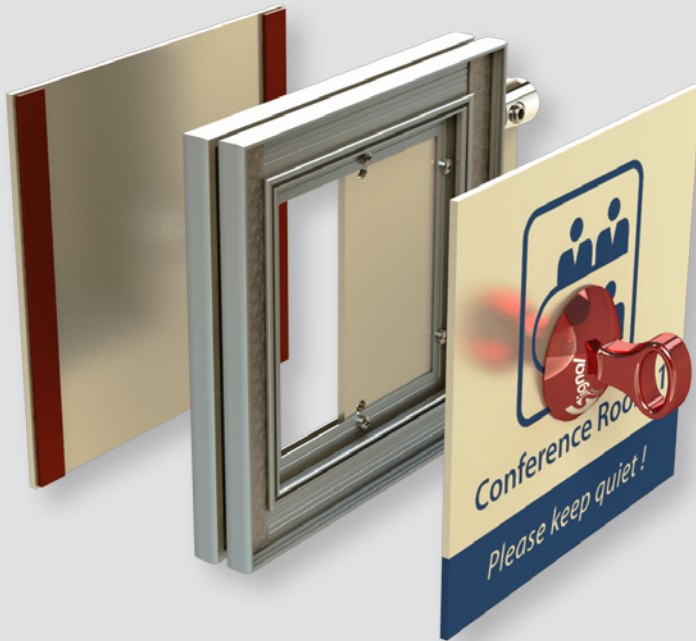

3

An LEF-PF-P unit with removable composite aluminum board faces using magnetic ribbons.



4

Installation using chrome plated spacers and a locking screws to the center plate.

LEPF-P-107

Commonly used unit height (other unit height can be ordered by demand)

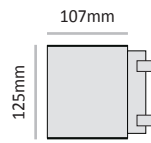

Cat. No.	LEPF-P-107-125mm
Unit Height	125mm
Insert size	107mm X 125mm

LEPF-P-153

Commonly used unit height (other unit height can be ordered by demand)

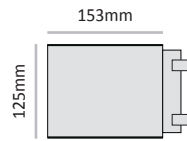

Cat. No.	LEPF-P-153-125mm
Unit Height	125mm
Insert size	153mm X 125mm

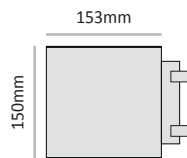

Cat. No.	LEPF-P-153-150mm
Unit Height	150mm
Insert size	153mm X 150mm

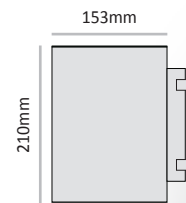

Cat. No.	LEPF-P-153-210mm
Unit Height	210mm
Insert size	153mm X 210mm

LEFPF-P-105

Commonly used unit height (other unit height can be ordered by demand)

Paper Insert Size = Overall - 3mm
Hard Panel Face Size = Overall - 4mm

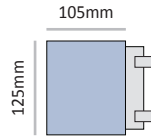

Cat. No.	LEFPF-P-105-125
Unit Size WxH	105mm x 125mm

LEFPF-P-125

Commonly used unit height (other unit height can be ordered by demand)

Paper Insert Size = Overall - 3mm
Hard Panel Face Size = Overall - 4mm

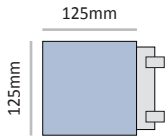

Cat. No.	LEFPF-P-125-125
Unit Size WxH	125mm x 125mm

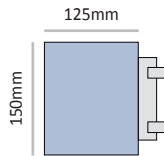

Cat. No.	LEFPF-P-125-150
Unit Size WxH	125mm x 150mm

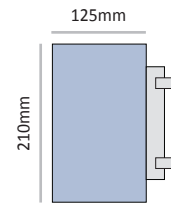

Cat. No.	LEFPF-P-125-210
Unit Size WxH	125mm x 210mm

LEFPF-P-150

Commonly used unit height (other unit height can be ordered by demand)

Paper Insert Size = Overall - 3mm
Hard Panel Face Size = Overall - 4mm

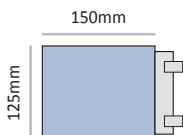

Cat. No.	LEFPF-P-150-125
Unit Size WxH	150mm x 125mm

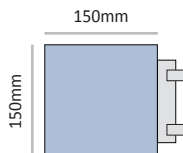

Cat. No.	LEFPF-P-150-150
Unit Size WxH	150mm x 150mm

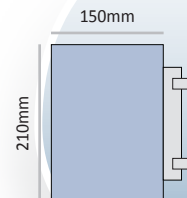

Cat. No.	LEFPF-P-150-210
Unit Size WxH	150mm x 210mm

LEFPF-P-210

Commonly used unit height (other unit height can be ordered by demand)

Paper Insert Size = Overall - 3mm
Hard Panel Face Size = Overall - 4mm

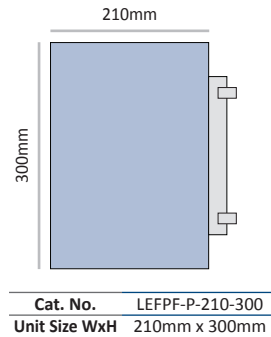
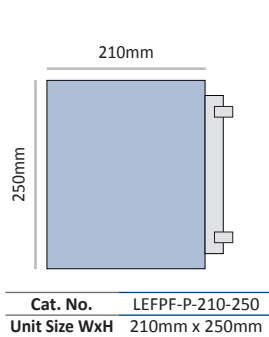
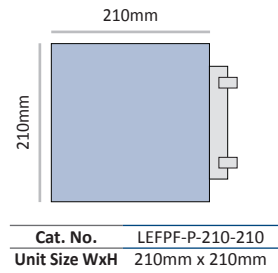
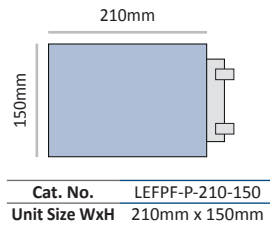
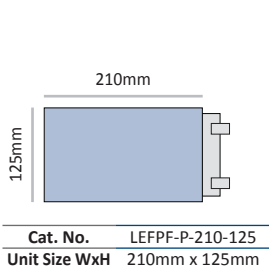

LEFPF-P-300

Commonly used unit height (other unit height can be ordered by demand)

Paper Insert Size = Overall - 3mm
Hard Panel Face Size = Overall - 4mm

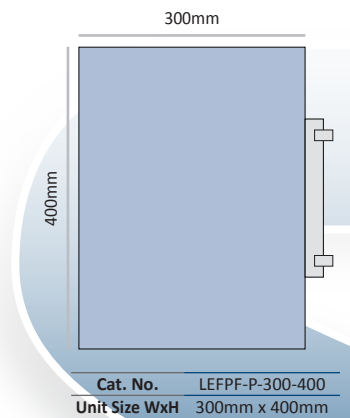
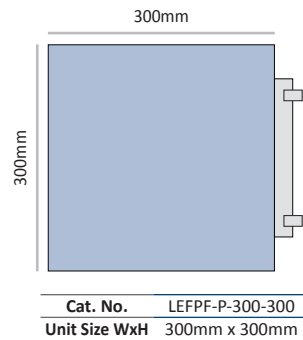
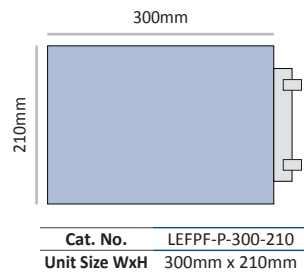
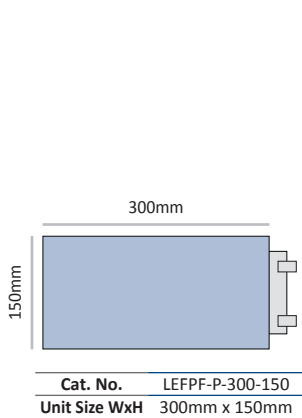



LETS is the Leader Edge table stand configuration using Leader Edge economy profiles.

LE-L or LE-P units attached to a formed anodized aluminum plate using screws to a designated channel within the profiles structure create a gently reclining welcoming appearance.

The LETS-L is a landscape configuration with side end caps, available in three height options: 55, 107 and 153mm (2", 4" and 6").

The LETS-P is a portrait configuration with top and bottom end caps available in two width options: 107mm and 153mm (4" and 6"). Commonly used sizes are presented; however, customized sizes are available upon request.

Changing the paper insert is simple and easy using our silicon suction cup. The ABS plastic end caps are available in three finishes to choose from: Grey, black and chrome plated.



LETS-L offers three standard profile height options: 55mm, 107mm and 153mm (2", 4" and 6").





LETS-P offers two standard profile width options: 107mm and 153mm (4" and 6").

LETS-L/P-H-W-EC	
LE	System Type - Leader Edge
TS	Table Stands
L/P	Sign layout - Landscape/Portrait
H	Sign Unit Height - mm
W	Sign Unit Width - mm
EC	End caps finish GR - Grey BK - Black CR - Chrome Plated

LETS-L-55

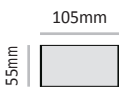
Commonly used unit width (other unit width can be ordered by demand)

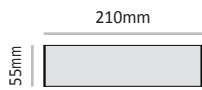
			
Cat. No. LETS-L-55-105	Cat. No. LETS-L-55-125	Cat. No. LETS-L-55-150	Cat. No. LETS-L-55-210
Unit Width 105 mm	Unit Width 125 mm	Unit Width 150 mm	Unit Width 210 mm
Insert size 52mm X 105mm	Insert size 52mm X 125mm	Insert size 52mm X 150mm	Insert size 52mm X 210mm

LETS-L-107

Commonly used unit width (other unit width can be ordered by demand)

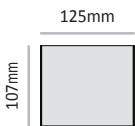
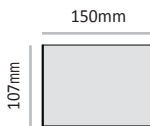
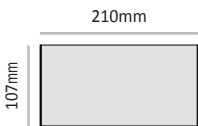
		
Cat. No. LETS-L-107-125	Cat. No. LETS-L-107-150	Cat. No. LETS-L-107-210
Unit Width 125 mm	Unit Width 150 mm	Unit Width 210 mm
Insert size 105mm X 125mm	Insert size 105mm X 150mm	Insert size 105mm X 210mm

LETS-L-153

Commonly used unit width (other unit width can be ordered by demand)

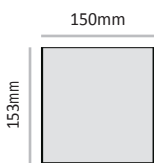
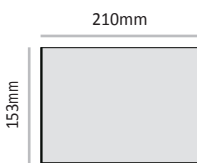
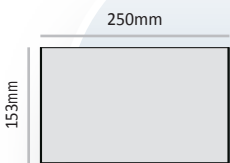
		
Cat. No. LETS-L-153-150	Cat. No. LETS-L-153-210	Cat. No. LETS-L-153-250
Unit Width 150 mm	Unit Width 210 mm	Unit Width 250 mm
Insert size 150mm X 150mm	Insert size 150mm X 210mm	Insert size 153mm X 250mm

LETS-P-107

Commonly used unit width (other unit width can be ordered by demand)

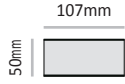

Cat. No.	LETS-P-107-50
Unit Height	50 mm
Insert size	105mm X 50mm

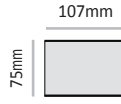

Cat. No.	LETS-P-107-75
Unit Height	75 mm
Insert size	105mm X 75mm

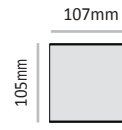

Cat. No.	LE-P-107-105
Unit Height	105 mm
Insert size	105mm X 105mm

LETS-P-153

Commonly used unit height (other unit height can be ordered by demand)

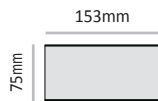

Cat. No.	LETS-P-153-75
Unit Height	75 mm
Insert size	150mm X 75mm

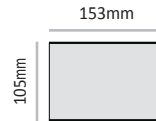

Cat. No.	LETS-P-153-105
Unit Height	105 mm
Insert size	150mm X 105mm

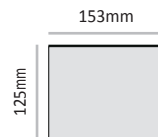

Cat. No.	LETS-P-153-125
Unit Height	125 mm
Insert size	150mm X 125mm

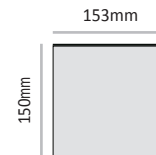

Cat. No.	LETS-P-153-150
Unit Height	150 mm
Insert size	150mm X 150mm