

# LEADER

by SIGNAL SIGN SYSTEMS LTD

# PRESTIGE



WAYFINDING SIGN SYSTEM



# LEADER PRESTIGE

## About Leader Prestige

The Leader Prestige features a series of elegant, practical and easy to install curved face profiles. It is available in 5 standard widths, ranging from 94 to 320mm fitted to be used with DIN standard paper sizes as printed inserts. The Leader Prestige offers an exclusive yet elegant wayfinding solution for door signs, table stands, projecting flags, suspended signs and small directories. The Leader Prestige is the perfect choice for your high end sign projects.

Unique rounded micro snap side clip profiles allow a fast and simple insert change without compromising its elegance. The side clips are offered in 5 spectacular colored anodized finishes: Silver, gold, black, red and blue. They all create a contemporary elegant design.

The variety of sizes and special designs is endless. The extrusions' design allows the use of a variety of insert materials and decorative techniques.

The Leader Prestige features a special channel shape design on the backside of the profiles allowing the use of concealed back plates. This special feature helps you create endless designs like shaped company logo plates as a background, room numbers, etc. This feature can also be used for special hidden installation solutions.

- **LP-L** Leader Prestige Wall Frames Landscape
- **LP-P** Leader Prestige Wall Frames Portrait
- **LPPF-L** Leader Prestige Projecting Flags Landscape
- **LPPF-P** Leader Prestige Projecting Flags Portrait
- **LPTS-L** Leader Prestige Table Stands Landscape
- **LPTS-P** Leader Prestige Table Stands Portrait
- **LP-DS-L** Leader Prestige Suspended Signs Landscape



**LP-L** is the Leader Prestige wall frame in a landscape configuration.

The LP-L is offered in five profile height options: 94, 124, 168, 230 and 320mm with endless length options.

These frames' insert heights are designed to fit the following DIN standard paper sizes: A7-A3.

The Leader prestige features unique rounded micro snap side profiles, allowing a fast and simple insert change without compromising its elegance. The side clips are offered in 5 spectacular colored anodized finishes: Silver, gold, black, red, and blue.

The Leader Prestige unique elegant appearance, is provided by the use of shiny stainless steel machined disc caps instead of plastic end caps.

All presented height options are commonly used sizes; however, customized widths are available upon request.

A variety of insert materials such as printed paper, ADA in photopolymer, engraved PVC, etched thin aluminum, silk printed plaques (and many other flexible inserts up to 1.6mm thick) can be used to create endless designs.

The smooth surface of the LP-L profile is suitable for a direct application of vinyl graphics.

The installation is very simple. A double sided self-adhesive tape can be applied to the back of the frame or concealed screws can be drilled through the sign profile.





1

Five standard profile height options: 94, 124, 168, 230 and 320mm.



2

Side clips are offered in 5 colored anodized finishes: silver, gold, black, red and blue.

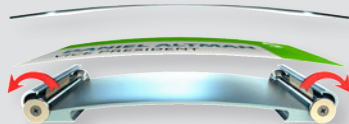

3

Swivel side snap clip profiles outward to remove inserts

LP-L-H-W-CF	
LP	System Type - Leader Prestige
L	Sign layout - Landscape
H	Sign Unit Height - mm
W	Sign Unit Width - mm
CF	Clips Finish S = Silver anodized G = Gold anodized R = Red anodized BL = Blue anodized BK = Black anodized



4

A decorative shaped background plate inserted in to the profiles' built in channel and locked with concealed screws.



5

Installation with concealed screws drilled through the sign profile.

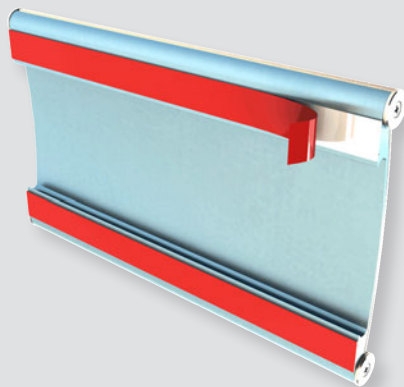

6

An easy installation using double sided self-adhesive tape on the back

The Leader Prestige features a special channel shape design on the backside of the profiles that allows the use of concealed back plates. This special feature helps you create endless designs like: shaped company logo plates as a background, room numbers, etc. This feature can also be used for special hidden installation solutions.

## LP-L-94

Commonly used unit width (other unit width can be ordered by demand)

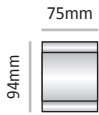

Cat. No.	LP-L-94-75
Unit Width	75 mm
Insert size	75mm X 75mm

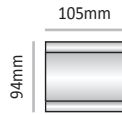

Cat. No.	LP-L-94-105
Unit Width	105 mm
Insert size	75mm X 105mm

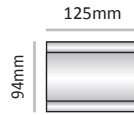

Cat. No.	LP-L-94-125
Unit Width	125 mm
Insert size	75mm X 125mm

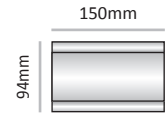

Cat. No.	LP-L-94-150
Unit Width	150 mm
Insert size	75mm X 150mm

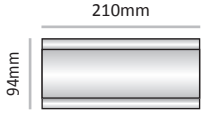

Cat. No.	LP-L-94-210
Unit Width	210 mm
Insert size	75mm X 210mm

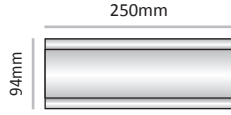

Cat. No.	LP-L-94-250
Unit Width	250 mm
Insert size	75mm X 250mm

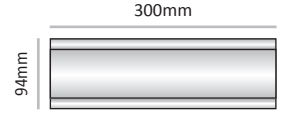

Cat. No.	LP-L-94-300
Unit Width	300 mm
Insert size	75mm X 300mm

## LP-L-124

Commonly used unit width (other unit width can be ordered by demand)

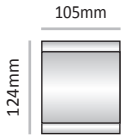

Cat. No.	LP-L-124-105
Unit Width	105 mm
Insert size	105mm X 105mm

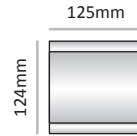

Cat. No.	LP-L-124-125
Unit Width	125 mm
Insert size	105mm X 125mm

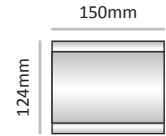

Cat. No.	LP-L-124-150
Unit Width	150 mm
Insert size	105mm X 150mm

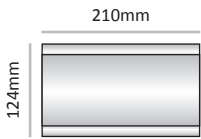

Cat. No.	LP-L-124-210
Unit Width	210 mm
Insert size	105mm X 210mm

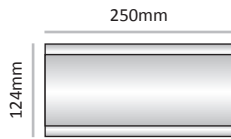

Cat. No.	LP-L-124-250
Unit Width	250 mm
Insert size	105mm X 250mm

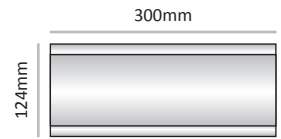

Cat. No.	LP-L-124-300
Unit Width	300 mm
Insert size	105mm X 300mm

## LP-L-168

Commonly used unit width (other unit width can be ordered by demand)

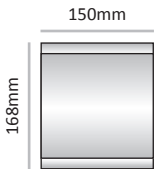

Cat. No.	LP-L-168-150
Unit Width	150 mm
Insert size	150mm X 150mm

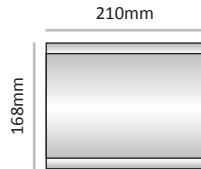

Cat. No.	LP-L-168-210
Unit Width	210 mm
Insert size	150mm X 210mm

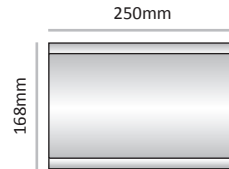

Cat. No.	LP-L-168-250
Unit Width	250 mm
Insert size	150mm X 250mm

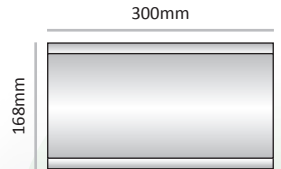

Cat. No.	LP-L-168-300
Unit Width	300 mm
Insert size	150mm X 300mm

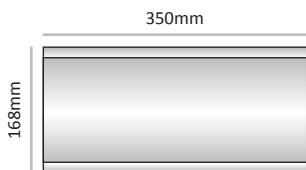

Cat. No.	LP-L-168-350
Unit Width	350 mm
Insert size	150mm X 350mm

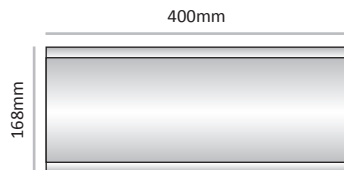

Cat. No.	LP-L-168-400
Unit Width	400 mm
Insert size	150mm X 400mm

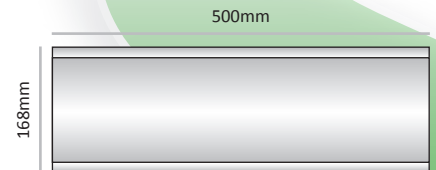

Cat. No.	LP-L-168-500
Unit Width	500 mm
Insert size	150mm X 500mm

## LP-L-230

Commonly used unit width (other unit width can be ordered by demand)

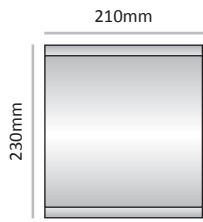

<b>Cat. No.</b>	LP-L-230-210
<b>Unit Width</b>	210 mm
<b>Insert size</b>	210mm X 210mm

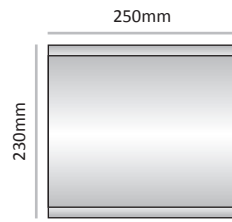

<b>Cat. No.</b>	LP-L-230-250
<b>Unit Width</b>	250 mm
<b>Insert size</b>	210mm X 250mm

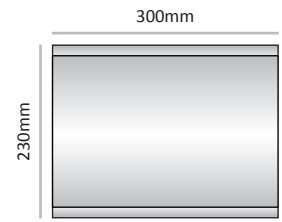

<b>Cat. No.</b>	LP-L-230-300
<b>Unit Width</b>	300 mm
<b>Insert size</b>	210mm X 300mm

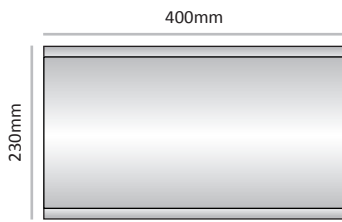

<b>Cat. No.</b>	LP-L-230-400
<b>Unit Width</b>	400 mm
<b>Insert size</b>	210mm X 400mm

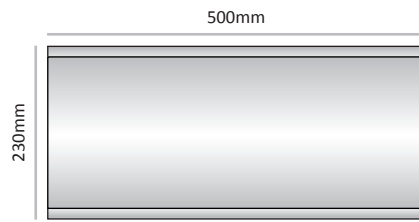

<b>Cat. No.</b>	LP-L-230-500
<b>Unit Width</b>	500 mm
<b>Insert size</b>	210mm X 500mm

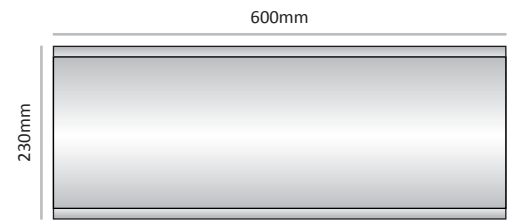

<b>Cat. No.</b>	LP-L-230-600
<b>Unit Width</b>	600 mm
<b>Insert size</b>	210mm X 600mm

## LP-L-320

Commonly used unit width (other unit width can be ordered by demand)

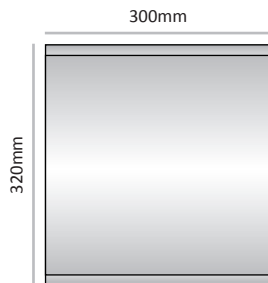

<b>Cat. No.</b>	LP-L-320-300
<b>Unit Width</b>	300 mm
<b>Insert size</b>	300mm X 300mm

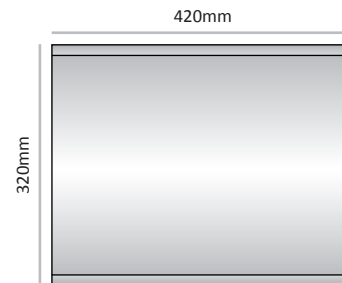

<b>Cat. No.</b>	LP-L-320-420
<b>Unit Width</b>	420 mm
<b>Insert size</b>	300mm X 420mm

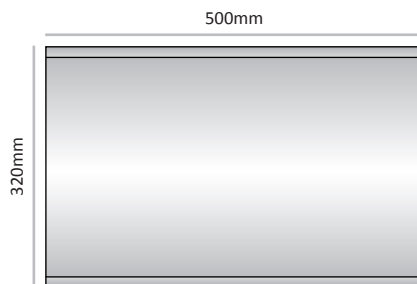

<b>Cat. No.</b>	LP-L-320-500
<b>Unit Width</b>	500 mm
<b>Insert size</b>	300mm X 500mm

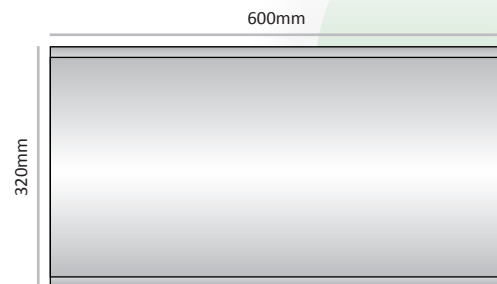

<b>Cat. No.</b>	LP-L-320-600
<b>Unit Width</b>	600 mm
<b>Insert size</b>	300mm X 600mm







**LP-P** is the Leader Prestige wall frame in a portrait configuration.

The LP-P is offered in five profile width options: 94, 124, 168, 230 and 320mm with endless height options.

These frames' insert widths are designed to fit the following DIN standard paper sizes: A7-A3.

The Leader prestige features unique rounded micro snap side profiles, allowing a fast and simple information change without compromising its elegance. The side clips are offered in 5 spectacular colored anodized finishes: Silver, gold, black, red, and blue.

The Leader Prestige unique elegant appearance, is provided by the use of shiny stainless steel machined disc caps instead of plastic end caps.

All presented width options are commonly used sizes; however, customized heights are available upon request.

A variety of insert materials such as: printed paper, ADA in photopolymer, engraved PVC, etched thin aluminum, silk printed plaques (and many other flexible substrates up to 1.6mm thick) can be used to create endless designs.

The smooth surface of the LP-P profile is suitable for a direct application of vinyl graphics.

The installation is very simple. A double sided self-adhesive tape can be applied to the back of the frame or concealed screws can be drilled through the sign profile.



1

Five standard profile width options: 94, 124, 168, 230 and 320mm.



2

Side clips are offered in 5 colored anodized finishes: silver, gold, black, red and blue.



4

An easy installation using double sided self-adhesive tape on the back



3

Installation with concealed screws drilled through the sign profile



5

Swivel side snap clip profiles outward to remove inserts

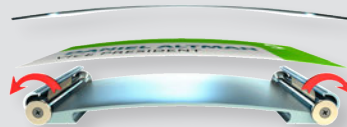

### LP-P-W-H-CF

LP	System Type - Leader Prestige
P	Sign layout - Portrait
W	Sign Unit Width - mm
H	Sign Unit Height - mm
CF	Clips Finish <b>S</b> = Silver anodized <b>G</b> = Gold anodized <b>R</b> = Red anodized <b>BL</b> = Blue anodized <b>BK</b> = Black anodized



6

A divided sign frame using a permanent anodized top strip with an interchangeable bottom section.

The Leader Prestige features a special channel shape design on the backside of the profiles allowing the use of concealed back plates. This special feature helps you create endless designs like shaped company logo plates as a background, room numbers, etc. This feature can be used also for special hidden installation solutions.



7

A Multiline unit with individual units stacked on a back plate.



8

A decorative shaped background plate inserted in to the profiles' built in channel and locked with concealed screws.

## LP-P-94

Commonly used unit height (other unit height can be ordered by demand)

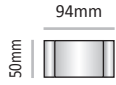

<b>Cat. No.</b>	LP-P-94-50
<b>Unit Height</b>	50 mm
<b>Insert size</b>	75mm X 50mm

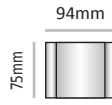

<b>Cat. No.</b>	LP-P-94-75
<b>Unit Height</b>	75 mm
<b>Insert size</b>	75mm X 75mm

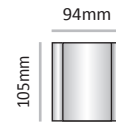

<b>Cat. No.</b>	LP-P-94-105
<b>Unit Height</b>	105 mm
<b>Insert size</b>	75mm X 105mm

## LP-P-124

Commonly used unit height (other unit height can be ordered by demand)

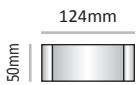

<b>Cat. No.</b>	LP-P-124-50
<b>Unit Height</b>	50 mm
<b>Insert size</b>	105mm X 50mm

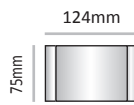

<b>Cat. No.</b>	LP-P-124-75
<b>Unit Height</b>	75 mm
<b>Insert size</b>	105mm X 75mm

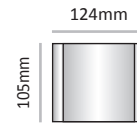

<b>Cat. No.</b>	LP-P-124-105
<b>Unit Height</b>	105 mm
<b>Insert size</b>	105mm X 105mm

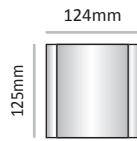

<b>Cat. No.</b>	LP-P-124-125
<b>Unit Height</b>	125 mm
<b>Insert size</b>	105mm X 125mm

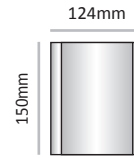

<b>Cat. No.</b>	LP-P-124-150
<b>Unit Height</b>	150 mm
<b>Insert size</b>	105mm X 150mm

## LP-P-168

Commonly used unit height (other unit height can be ordered by demand)

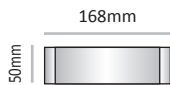

<b>Cat. No.</b>	LP-P-168-50
<b>Unit Height</b>	50 mm
<b>Insert size</b>	150mm X 50mm

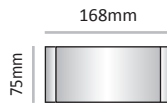

<b>Cat. No.</b>	LP-P-168-75
<b>Unit Height</b>	75 mm
<b>Insert size</b>	150mm X 75mm

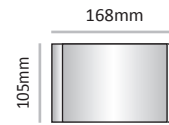

<b>Cat. No.</b>	LP-P-168-105
<b>Unit Height</b>	105 mm
<b>Insert size</b>	150mm X 105mm

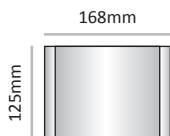

<b>Cat. No.</b>	LP-P-168-125
<b>Unit Height</b>	125 mm
<b>Insert size</b>	150mm X 125mm

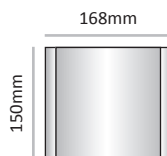

<b>Cat. No.</b>	LP-P-168-150
<b>Unit Height</b>	150 mm
<b>Insert size</b>	150mm X 150mm

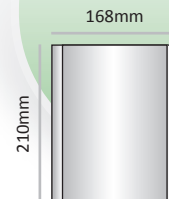

<b>Cat. No.</b>	LP-P-168-210
<b>Unit Height</b>	210 mm
<b>Insert size</b>	150mm X 210mm

## LP-L-230

Commonly used unit height (other unit height can be ordered by demand)

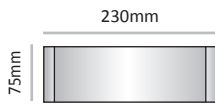

<b>Cat. No.</b>	LP-P-230-75
<b>Unit Height</b>	75 mm
<b>Insert size</b>	210mm X 75mm

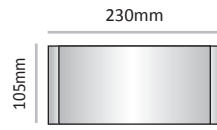

<b>Cat. No.</b>	LP-P-230-105
<b>Unit Height</b>	105 mm
<b>Insert size</b>	210mm X 105mm

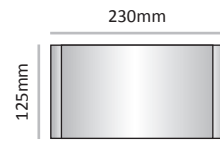

<b>Cat. No.</b>	LP-P-230-125
<b>Unit Height</b>	125 mm
<b>Insert size</b>	210mm X 125mm

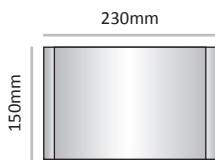

<b>Cat. No.</b>	LP-P-230-150
<b>Unit Height</b>	150 mm
<b>Insert size</b>	210mm X 150mm

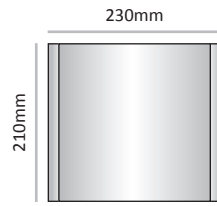

<b>Cat. No.</b>	LP-P-230-210
<b>Unit Height</b>	210 mm
<b>Insert size</b>	210mm X 210mm

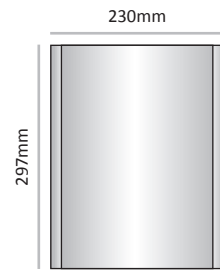

<b>Cat. No.</b>	LP-P-230-297
<b>Unit Height</b>	297 mm
<b>Insert size</b>	210mm X 297mm

## LP-P-320

Commonly used unit height (other unit height can be ordered by demand)

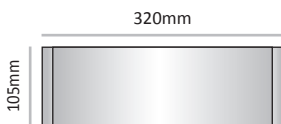

<b>Cat. No.</b>	LP-P-320-105
<b>Unit Height</b>	105 mm
<b>Insert size</b>	300mm X 105mm



<b>Cat. No.</b>	LP-P-320-125
<b>Unit Height</b>	125 mm
<b>Insert size</b>	300mm X 125mm

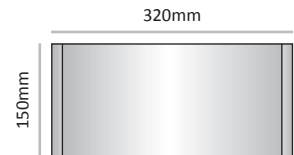

<b>Cat. No.</b>	LP-P-320-150
<b>Unit Height</b>	150 mm
<b>Insert size</b>	300mm X 150mm

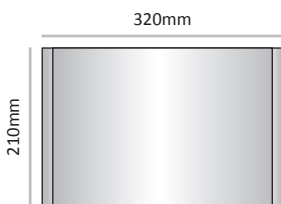

<b>Cat. No.</b>	LP-P-320-210
<b>Unit Height</b>	210 mm
<b>Insert size</b>	300mm X 210mm

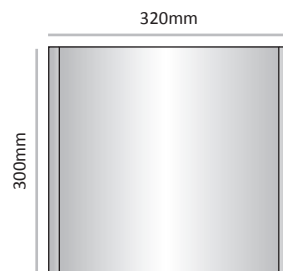

<b>Cat. No.</b>	LP-P-320-297
<b>Unit Height</b>	297 mm
<b>Insert size</b>	300mm X 297mm

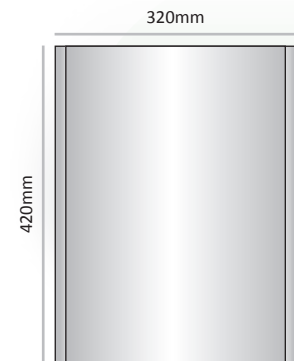

<b>Cat. No.</b>	LP-P-320-420
<b>Unit Height</b>	420 mm
<b>Insert size</b>	300mm X 420mm





**LPPF-L** is a projecting flag sign in a landscape configuration.

This elegant yet simple and straight forward double sided projecting flag sign is created by attaching two Leader Prestige profiles back to back, bolted to an oval shaped anodized aluminum base plate.

The LPPF-L is available in five heights: 94, 124, 168, 230 and 320mm with endless length options.

All presented length options are commonly used sizes; however, customized lengths are available upon request.

The Leader prestige features unique rounded micro snap side profiles, allowing a fast and simple insert change without compromising its elegance. The side clips are offered in 5 spectacular colored anodized finishes: Silver, gold, black, red, and blue.

The Leader Prestige's profile's smooth face is great for direct vinyl graphics application or printed paper inserts as well.

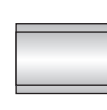



1

Five standard profile height options: 94, 124, 168, 230 and 320mm.

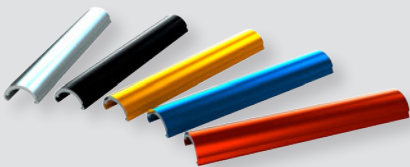

2

Side clips are offered in 5 colored anodized finishes: silver, gold, black, red and blue.

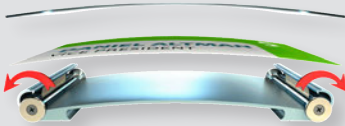

3

Swivel side snap clip profiles outward to remove inserts.



4

Double sided anodized aluminum cap and oval base plate are positioned on the sides to hold the two back to back Leader Prestige projecting profiles

LPPF-L-H-W-CF	
LPPF	System Type - Leader Prestige Projecting Flags
L	Sign layout - Landscape
H	Sign Unit Height - mm
W	Sign Unit Width - mm
CF	Clips Finish <b>S</b> = Silver anodized <b>G</b> = Gold anodized <b>R</b> = Red anodized <b>BL</b> = Blue anodized <b>BK</b> = Black anodized



### LPPF-L-94

Commonly used unit height (other unit height can be ordered by demand)



<b>Cat. No.</b> LPPF-L-94-105 <b>Unit Width</b> 105 mm <b>Insert size</b> 75mm X 105mm	<b>Cat. No.</b> LPPF-L-94-125 <b>Unit Width</b> 125 mm <b>Insert size</b> 75mm X 125mm	<b>Cat. No.</b> LPPF-L-94-150 <b>Unit Width</b> 150 mm <b>Insert size</b> 75mm X 150mm	<b>Cat. No.</b> LPPF-L-94-210 <b>Unit Width</b> 210 mm <b>Insert size</b> 75mm X 210mm	<b>Cat. No.</b> LPPF-L-94-250 <b>Unit Width</b> 250 mm <b>Insert size</b> 75mm X 250mm

### LPPF-L-124

Commonly used unit width (other unit width can be ordered by demand)



<b>Cat. No.</b> LPPF-L-124-105 <b>Unit Width</b> 105 mm <b>Insert size</b> 105mm X 105mm	<b>Cat. No.</b> LPPF-L-124-125 <b>Unit Width</b> 125 mm <b>Insert size</b> 105mm X 125mm	<b>Cat. No.</b> LPPF-L-124-150 <b>Unit Width</b> 150 mm <b>Insert size</b> 105mm X 150mm	<b>Cat. No.</b> LPPF-L-124-210 <b>Unit Width</b> 210 mm <b>Insert size</b> 105mm X 210mm	<b>Cat. No.</b> LPPF-L-124-300 <b>Unit Width</b> 300 mm <b>Insert size</b> 105mm X 300mm

### LPPF-L-168

Commonly used unit width (other unit width can be ordered by demand)



<b>Cat. No.</b> LPPF-L-168-150 <b>Unit Width</b> 150 mm <b>Insert size</b> 150mm X 150mm	<b>Cat. No.</b> LPPF-L-168-210 <b>Unit Width</b> 210 mm <b>Insert size</b> 150mm X 210mm	<b>Cat. No.</b> LPPF-L-168-250 <b>Unit Width</b> 250 mm <b>Insert size</b> 150mm X 250mm	<b>Cat. No.</b> LPPF-L-168-300 <b>Unit Width</b> 300 mm <b>Insert size</b> 150mm X 300mm

## LPPF-L-230

Commonly used unit height (other unit height can be ordered by demand)

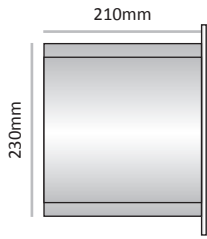

<b>Cat. No.</b>	LPPF-L-230-210
<b>Unit Width</b>	210 mm
<b>Insert size</b>	210mm X 210mm

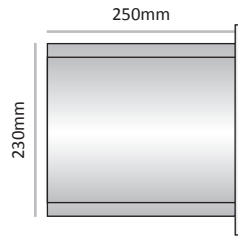

<b>Cat. No.</b>	LPPF-L-230-250
<b>Unit Width</b>	250 mm
<b>Insert size</b>	210mm X 250mm

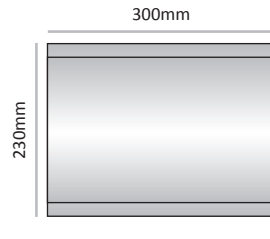

<b>Cat. No.</b>	LPPF-L-230-300
<b>Unit Width</b>	300 mm
<b>Insert size</b>	210mm X 300mm

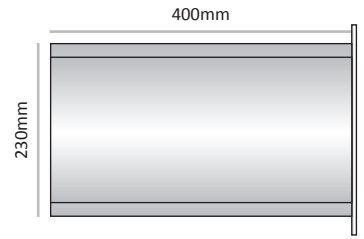

<b>Cat. No.</b>	LPPF-L-230-400
<b>Unit Width</b>	400 mm
<b>Insert size</b>	210mm X 400mm

## LPPF-L-320

Commonly used unit height (other unit height can be ordered by demand)

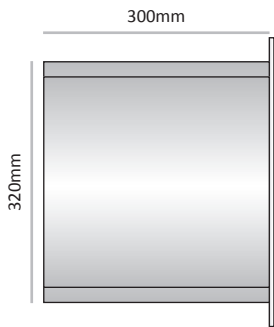

<b>Cat. No.</b>	LPPF-L-320-300
<b>Unit Width</b>	300 mm
<b>Insert size</b>	300mm X 300mm

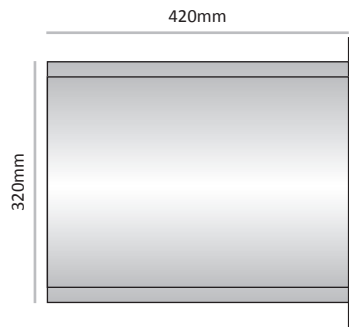

<b>Cat. No.</b>	LPPF-L-320-420
<b>Unit Width</b>	420 mm
<b>Insert size</b>	300mm X 420mm

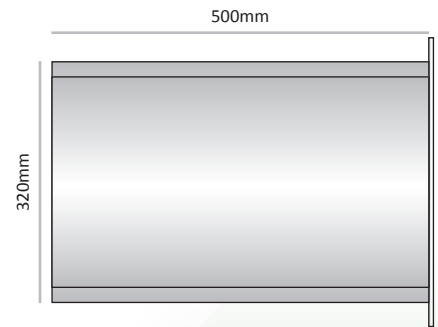

<b>Cat. No.</b>	LPPF-L-320-500
<b>Unit Width</b>	500 mm
<b>Insert size</b>	300mm X 500mm



**LPPF-P** is a projecting flag sign in a portrait configuration.

This is a curved triangle shaped double sided sign with top and bottom anodized aluminum machined end caps attached to Leader Prestige profiles, which are projected out of a mounting base plate with specially designed silver polished brass spacers. This design creates a unique appearance.

The LPPF-P is available in four widths: 124, 168, 230 and 320mm with endless height options.

All presented height options are commonly used sizes; however, customized heights are available upon request.

The Leader prestige features unique rounded micro snap side profiles, allowing a fast and simple insert change without compromising its elegance. The side clips are offered in 5 spectacular colored anodized finishes: Silver, gold, black, red, and blue.

The LPPF-P features a unique mounting technique. The base plate and the sign unit are locked together using special cylindrical spacers that conveniently allow the base plate to be installed separately.



1

Four standard profile height options:  
124, 168, 230 and 320mm.



2

Side clips are offered in 5 colored anodized finishes: Silver, gold, black, red and blue.



3

Swivel side snap clip profiles outward to remove inserts.

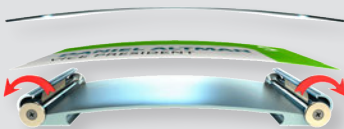

4

A unique mounting technique using special cylindrical spacers which conveniently allow the base plate to be installed separately from the sign frame



**LPPF-P-W-H-CF**

LPPF	System Type - Leader Prestige Projecting Flags
P	Sign layout - Portrait
W	Sign Unit Width - mm
H	Sign Unit Height - mm
CF	Clips Finish <b>S</b> = Silver anodized <b>G</b> = Gold anodized <b>R</b> = Red anodized <b>BL</b> = Blue anodized <b>BK</b> = Black anodized

### LPPF-P-124

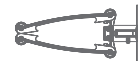

Commonly used unit height (other unit height can be ordered by demand)

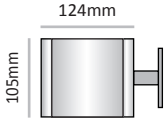
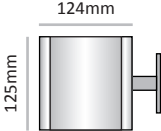
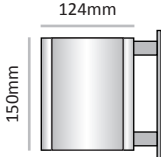
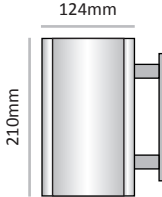
			
<b>Cat. No.</b> LPPF-P-124-105	<b>Cat. No.</b> LPPF-P-124-125	<b>Cat. No.</b> LPPF-P-124-150	<b>Cat. No.</b> LPPF-P-124-210
<b>Unit Height</b> 105 mm	<b>Unit Height</b> 125 mm	<b>Unit Height</b> 150 mm	<b>Unit Height</b> 210 mm
<b>Insert size</b> 105mm X 105mm	<b>Insert size</b> 105mm X 125mm	<b>Insert size</b> 105mm X 150mm	<b>Insert size</b> 105mm X 210mm

### LPPF-P-168

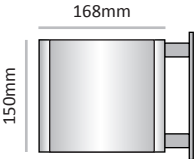
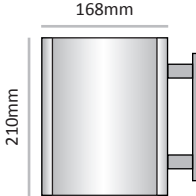
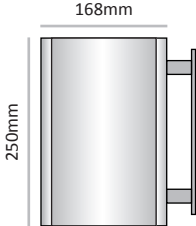
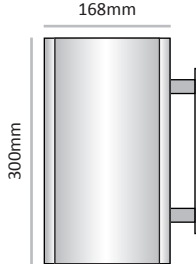

Commonly used unit height (other unit height can be ordered by demand)

			
<b>Cat. No.</b> LPPF-P-170-150	<b>Cat. No.</b> LPPF-P-170-210	<b>Cat. No.</b> LPPF-P-170-250	<b>Cat. No.</b> LPPF-P-170-300
<b>Unit Height</b> 150 mm	<b>Unit Height</b> 210 mm	<b>Unit Height</b> 250 mm	<b>Unit Height</b> 300 mm
<b>Insert size</b> 150mm X 150mm	<b>Insert size</b> 150mm X 210mm	<b>Insert size</b> 150mm X 250mm	<b>Insert size</b> 150mm X 300mm

### LPPF-P-230

Commonly used unit height (other unit height can be ordered by demand)

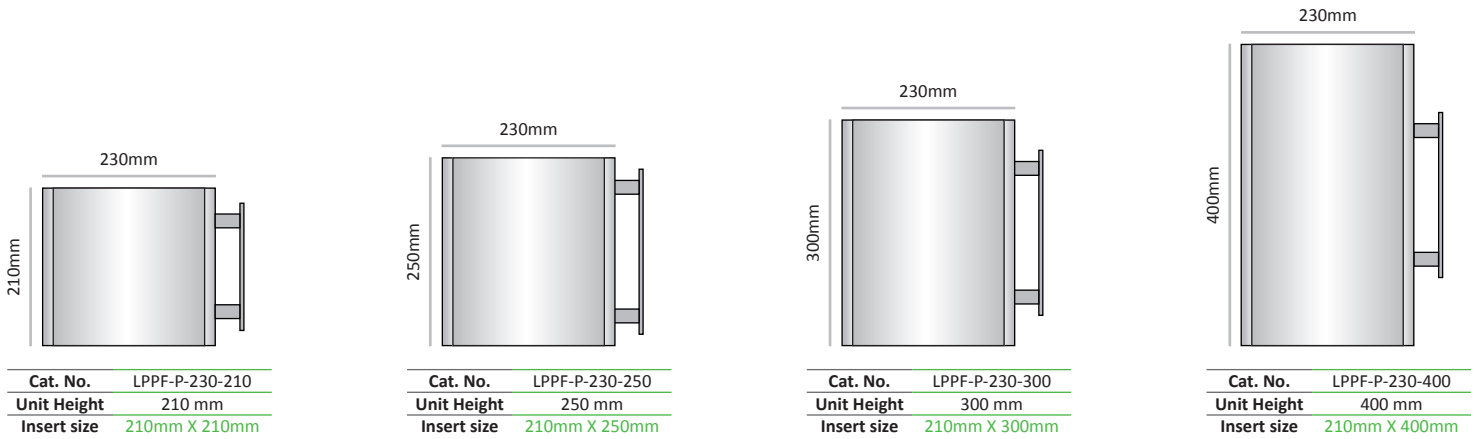

### LPPF-P-320

Commonly used unit height (other unit height can be ordered by demand)

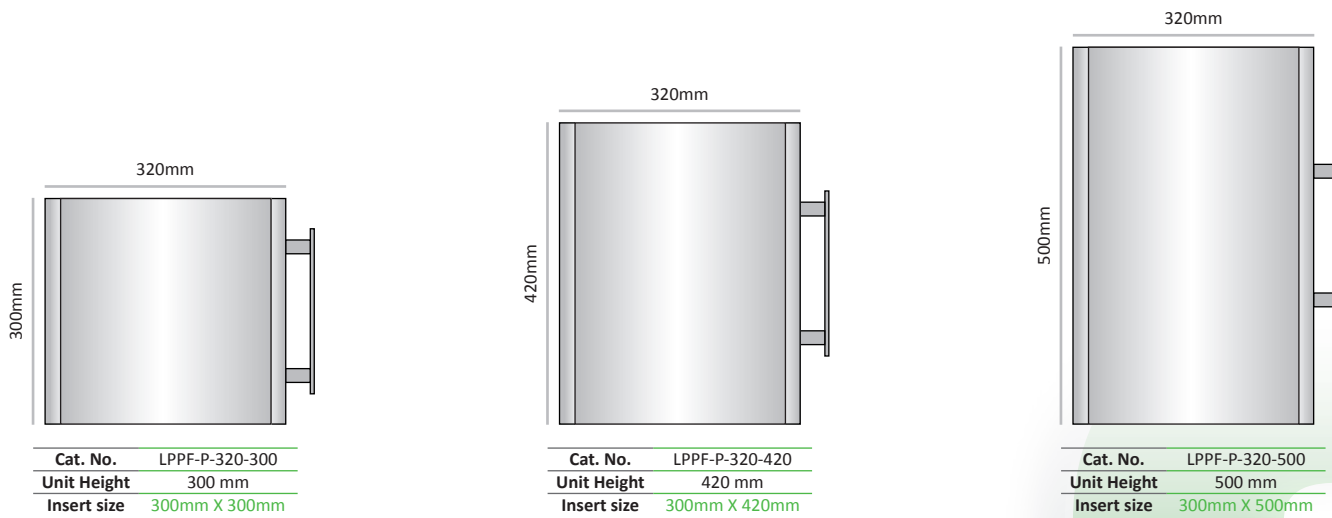



**LPTS-L** is a table stand in a landscape configuration using Leader Prestige profiles.

Shark fin shaped anodized aluminum side caps provide stability to either single or double sided units. A gently reclining appearance combined with round edged side caps creates a very welcoming look.

The LPTS-L is available in five heights: 94, 124, 168, 230 and 320mm with endless width options.

All presented width options are commonly used sizes; however, customized widths are available upon request.

The Leader prestige features unique rounded micro snap side profiles, allowing a fast and simple insert change without compromising its elegance. The side clips are offered in 5 spectacular colored anodized finishes: Silver, gold, black, red, and blue.



1

Five standard profile height options: 94, 124, 168, 230 and 320mm.



2

Side clips are offered in 5 colored anodized finishes: Silver, gold, black, red and blue.

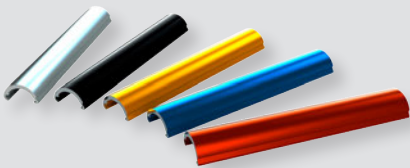

4

A Double Sided configuration



3

Swivel side snap clip profiles outward to remove inserts.

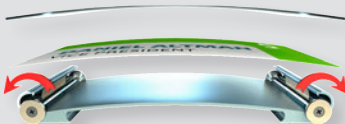

5

An easy insert removal using the snap side clip profiles.

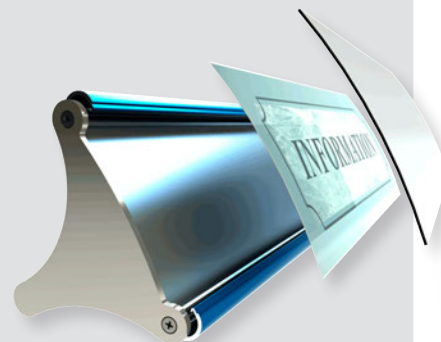

LPTS-L-H-W-CF	
LPTS	System Type - Leader Prestige Table Stands
L	Sign layout - Landscape
H	Sign Unit Height - mm
W	Sign Unit Width - mm
SS/DS	Single Sided/Double Sided
CF	Clips Finish <b>S</b> = Silver anodized <b>G</b> = Gold anodized <b>R</b> = Red anodized <b>BL</b> = Blue anodized <b>BK</b> = Black anodized



## LPTS-L-94

Commonly used unit height (other unit height can be ordered by demand)

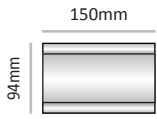

<b>Cat. No.</b>	LPTS-L-94-150
<b>Unit Width</b>	150 mm
<b>Insert size</b>	75mm X 150mm

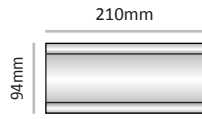

<b>Cat. No.</b>	LPTS-L-94-210
<b>Unit Width</b>	210 mm
<b>Insert size</b>	75mm X 210mm

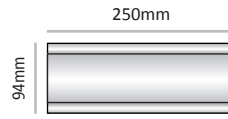

<b>Cat. No.</b>	LPTS-L-94-250
<b>Unit Width</b>	250 mm
<b>Insert size</b>	75mm X 250mm

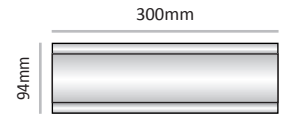

<b>Cat. No.</b>	LPTS-L-94-300
<b>Unit Width</b>	300 mm
<b>Insert size</b>	75mm X 300mm

## LPTS-L-124

Commonly used unit width (other unit width can be ordered by demand)

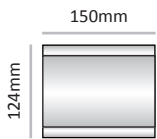

<b>Cat. No.</b>	LPTS-L-124-150
<b>Unit Width</b>	150 mm
<b>Insert size</b>	105mm X 150mm

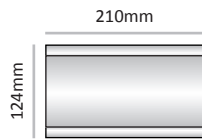

<b>Cat. No.</b>	LPTS-L-124-210
<b>Unit Width</b>	210 mm
<b>Insert size</b>	105mm X 210mm

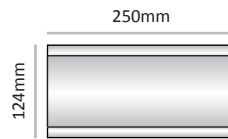

<b>Cat. No.</b>	LPTS-L-124-250
<b>Unit Width</b>	250 mm
<b>Insert size</b>	105mm X 250mm

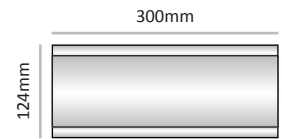

<b>Cat. No.</b>	LPTS-L-124-300
<b>Unit Width</b>	300 mm
<b>Insert size</b>	105mm X 300mm

## LPTS-L-168

Commonly used unit width (other unit width can be ordered by demand)

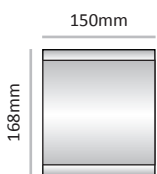
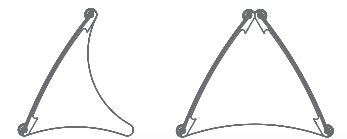

<b>Cat. No.</b>	LPTS-L-168-150
<b>Unit Width</b>	150 mm
<b>Insert size</b>	150mm X 150mm

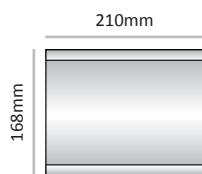

<b>Cat. No.</b>	LPTS-L-168-210
<b>Unit Width</b>	210 mm
<b>Insert size</b>	150mm X 210mm

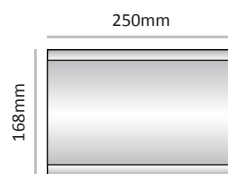

<b>Cat. No.</b>	LPTS-L-168-250
<b>Unit Width</b>	250 mm
<b>Insert size</b>	150mm X 250mm

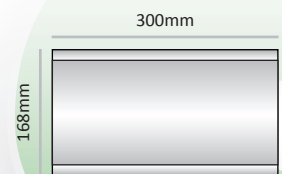

<b>Cat. No.</b>	LPTS-L-168-300
<b>Unit Width</b>	300 mm
<b>Insert size</b>	150mm X 300mm

### LPTS-L-230

Commonly used unit height (other unit height can be ordered by demand)

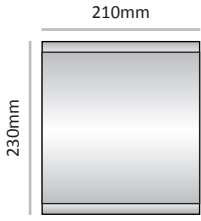
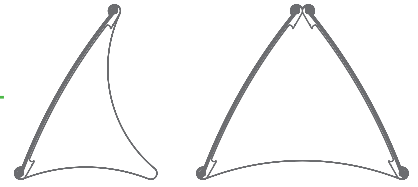

<b>Cat. No.</b>	LPTS-L-230-210
<b>Unit Width</b>	210 mm
<b>Insert size</b>	210mm X 210mm

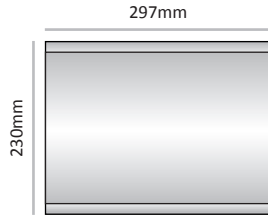

<b>Cat. No.</b>	LPTS-L-230-297
<b>Unit Width</b>	297 mm
<b>Insert size</b>	210mm X 297mm

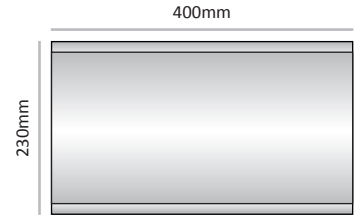

<b>Cat. No.</b>	LPTS-L-230-400
<b>Unit Width</b>	400 mm
<b>Insert size</b>	210mm X 400mm

### LPTS-L-320

Commonly used unit height (other unit height can be ordered by demand)

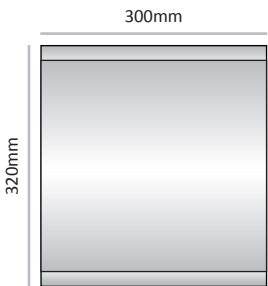
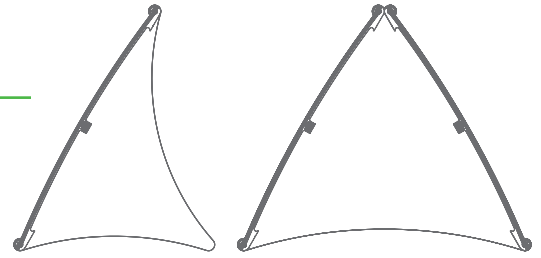

<b>Cat. No.</b>	LPTS-L-320-300
<b>Unit Width</b>	300 mm
<b>Insert size</b>	300mm X 300mm

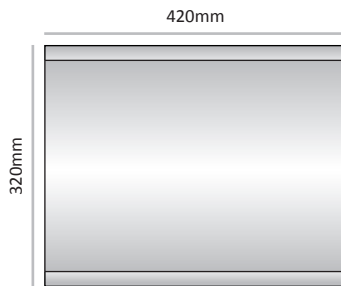

<b>Cat. No.</b>	LPTS-L-320-420
<b>Unit Width</b>	420 mm
<b>Insert size</b>	300mm X 420mm

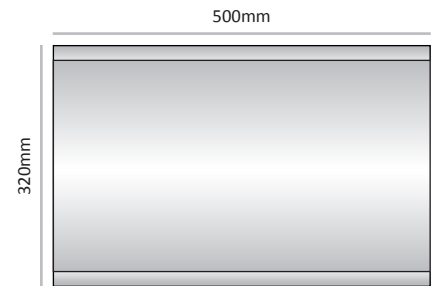

<b>Cat. No.</b>	LPTS-L-320-500
<b>Unit Width</b>	500 mm
<b>Insert size</b>	300mm X 500mm



**LPTS-P** is a table stand in a portrait configuration using Leader Prestige profiles.

An oval shaped anodized aluminum base is used in single and double sided units.

The LPTS-P is available in five widths: 94, 124, 168, 230 and 320mm with endless height options.

All presented height options are commonly used sizes; however, customized heights are available upon request.

The Leader prestige features unique rounded micro snap side profiles, allowing a fast and simple insert change without compromising its elegance. The side clips are offered in 5 spectacular colored anodized finishes: Silver, gold, black, red, and blue.





1

A Double Sided configuration

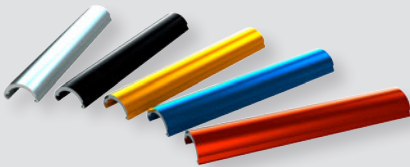

2

Side clips are offered in 5 colored anodized finishes: Silver, gold, black, red and blue.

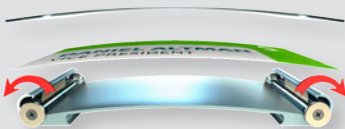

3

Swivel side snap clip profiles outward to remove inserts.



4

A Single Sided configuration

LPTS-P-W-H-CF	
LPTS	System Type - Leader Prestige Table Stands
P	Sign layout - Portrait
W	Sign Unit Width - mm
H	Sign Unit Height - mm
SS/DS	Single Sided/Double Sided
CF	Clips Finish <b>S</b> = Silver anodized <b>G</b> = Gold anodized <b>R</b> = Red anodized <b>BL</b> = Blue anodized <b>BK</b> = Black anodized

## LPTS-P-94

Commonly used unit height (other unit height can be ordered by demand)

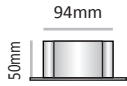
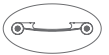

<b>Cat. No.</b>	LPTS-P-94-50
<b>Unit Height</b>	50 mm
<b>Insert size</b>	75mm X 50mm

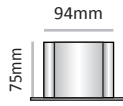

<b>Cat. No.</b>	LPTS-P-94-75
<b>Unit Height</b>	75 mm
<b>Insert size</b>	75mm X 75mm

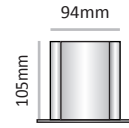

<b>Cat. No.</b>	LPTS-P-94-105
<b>Unit Height</b>	105 mm
<b>Insert size</b>	75mm X 105mm

## LPTS-P-124

Commonly used unit height (other unit height can be ordered by demand)

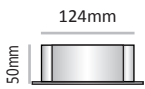

<b>Cat. No.</b>	LPTS-P-124-50
<b>Unit Height</b>	50 mm
<b>Insert size</b>	105mm X 50mm

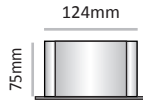

<b>Cat. No.</b>	LPTS-P-124-75
<b>Unit Height</b>	75 mm
<b>Insert size</b>	105mm X 75mm

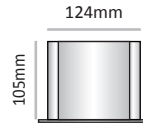

<b>Cat. No.</b>	LPTS-P-124-105
<b>Unit Height</b>	105 mm
<b>Insert size</b>	105mm X 105mm

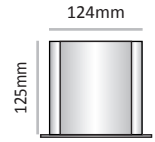

<b>Cat. No.</b>	LPTS-P-124-125
<b>Unit Height</b>	125 mm
<b>Insert size</b>	105mm X 125mm

## LPTS-P-168

Commonly used unit height (other unit height can be ordered by demand)

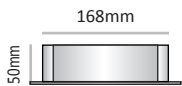

<b>Cat. No.</b>	LPTS-P-168-50
<b>Unit Height</b>	50 mm
<b>Insert size</b>	150mm X 50mm

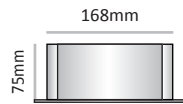

<b>Cat. No.</b>	LPTS-P-170-75
<b>Unit Height</b>	75 mm
<b>Insert size</b>	150mm X 75mm

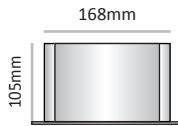

<b>Cat. No.</b>	LPTS-P-168-105
<b>Unit Height</b>	105 mm
<b>Insert size</b>	150mm X 105mm

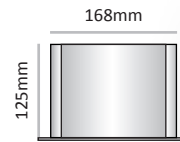

<b>Cat. No.</b>	LPTS-P-168-125
<b>Unit Height</b>	125 mm
<b>Insert size</b>	150mm X 125mm

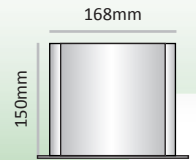

<b>Cat. No.</b>	LPTS-P-168-150
<b>Unit Height</b>	150 mm
<b>Insert size</b>	150mm X 150mm

## LPTS-P-230

Commonly used unit height (other unit height can be ordered by demand)

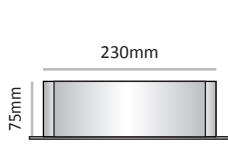

<b>Cat. No.</b>	LPTS-P-230-75
<b>Unit Height</b>	75 mm
<b>Insert size</b>	210mm X 75mm

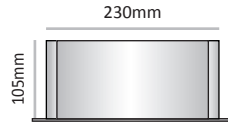

<b>Cat. No.</b>	LPTS-P-230-105
<b>Unit Height</b>	105 mm
<b>Insert size</b>	210mm X 105mm

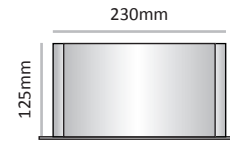

<b>Cat. No.</b>	LPTS-P-230-125
<b>Unit Height</b>	125 mm
<b>Insert size</b>	210mm X 125mm

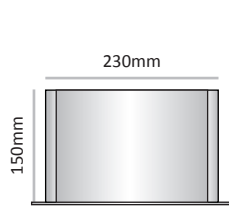

<b>Cat. No.</b>	LPTS-P-230-150
<b>Unit Height</b>	150 mm
<b>Insert size</b>	210mm X 150mm

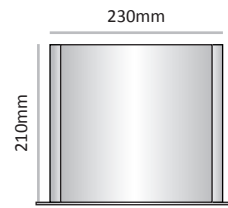

<b>Cat. No.</b>	LPTS-P-230-210
<b>Unit Height</b>	210 mm
<b>Insert size</b>	210mm X 210mm

## LPTS-P-320

Commonly used unit height (other unit height can be ordered by demand)

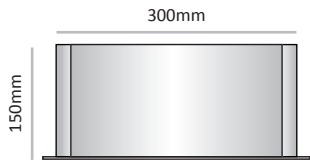
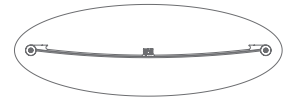

<b>Cat. No.</b>	LPTS-P-320-150
<b>Unit Height</b>	150 mm
<b>Insert size</b>	300mm X 150mm

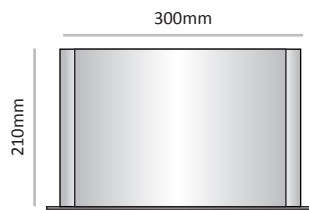

<b>Cat. No.</b>	LPTS-P-320-210
<b>Unit Height</b>	210 mm
<b>Insert size</b>	300mm X 210mm

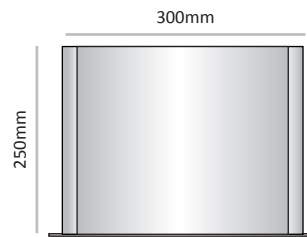

<b>Cat. No.</b>	LPTS-P-320-250
<b>Unit Height</b>	250 mm
<b>Insert size</b>	300mm X 250mm

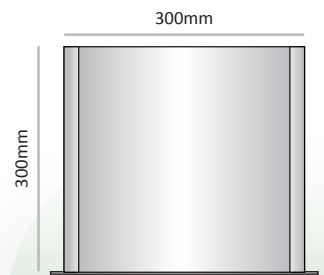

<b>Cat. No.</b>	LPTS-P-320-300
<b>Unit Height</b>	300 mm
<b>Insert size</b>	300mm X 300mm



**LP-DS-L** is a double sided suspended sign frame in a landscape configuration.

Double side anodized aluminum caps are positioned on the sides to hold two back to back Leader Prestige profiles and create a simple yet elegant curved face suspended sign.

The LP-DS-L is available in five standard heights: 94, 124, 168, 230, and 320mm with endless width options.

All presented width options are commonly used sizes; however, customized widths are available upon request.

The Leader prestige features unique rounded micro snap side profiles, allowing a fast and simple insert change without compromising its elegance. The side clips are offered in 5 spectacular colored anodized finishes: Silver, gold, black, red, and blue.

The installation can be done by using chrome plated auto lock cable grip ceiling anchors.

Vinyl graphics can be applied directly on the profile's smooth curved face, or a printed paper can be used as artwork with a clear lens cover.

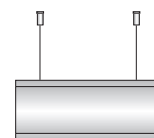



1

Five standard profile height options: 94, 124, 168, 230 and 320mm.

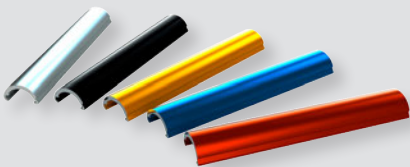

2

Side clips are offered in 5 colored anodized finishes: Silver, gold, black, red and blue.

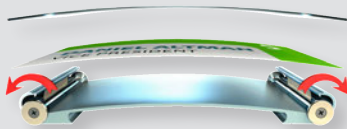

3

Swivel side snap clip profiles outward to remove inserts

LP-DS-L-H-W-CF	
LP	System Type - Leader Prestige
DS	Double Sided
L	Sign layout - Landscape
H	Sign Unit Height - mm
W	Sign Unit Width - mm
CF	Clips Finish <b>S</b> = Silver anodized <b>G</b> = Gold anodized <b>R</b> = Red anodized <b>BL</b> = Blue anodized <b>BK</b> = Black anodized



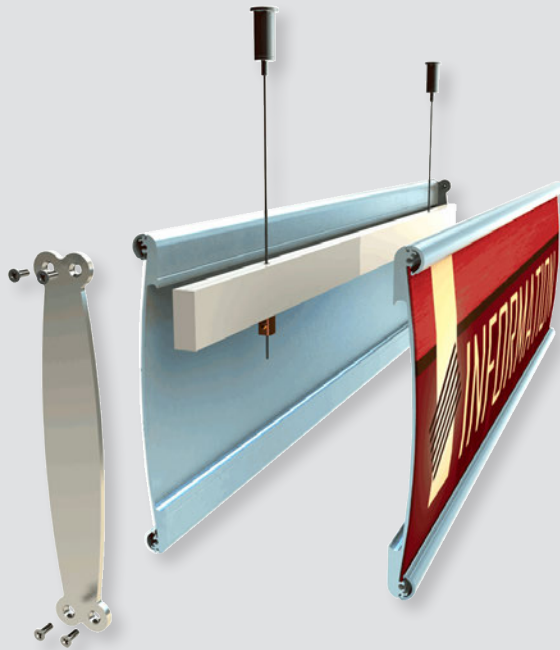

5

Double sided anodized aluminum caps are positioned on the sides to hold the two back to back Leader Prestige profiles



6

Installation can be done by using chrome plated auto lock cable grip ceiling anchors and PVC coated steel cable.



7

An easy insert removal using the snap side clip profiles

## LP-DS-L-94

Commonly used unit height (other unit height can be ordered by demand)

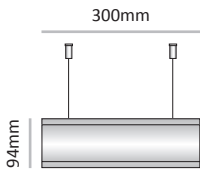

<b>Cat. No.</b>	LP-DS-L-94-300
<b>Unit Width</b>	300 mm
<b>Insert size</b>	75mm X 300mm

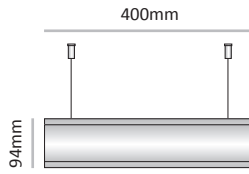

<b>Cat. No.</b>	LP-DS-L-94-400
<b>Unit Width</b>	400 mm
<b>Insert size</b>	75mm X 400mm

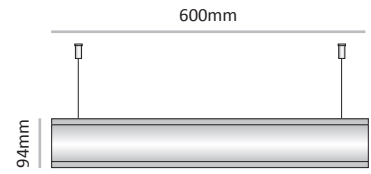

<b>Cat. No.</b>	LP-DS-L-94-600
<b>Unit Width</b>	600 mm
<b>Insert size</b>	75mm X 600mm

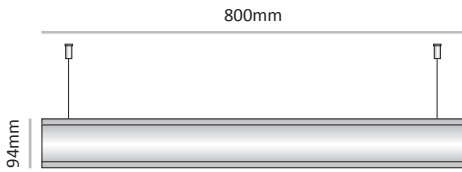

<b>Cat. No.</b>	LP-DS-L-94-800
<b>Unit Width</b>	800 mm
<b>Insert size</b>	75mm X 800mm

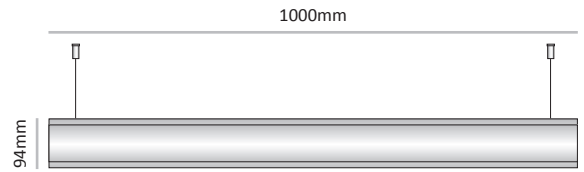

<b>Cat. No.</b>	LP-DS-L-94-1000
<b>Unit Width</b>	1000 mm
<b>Insert size</b>	75mm X 1000mm

## LP-DS-L-124

Commonly used unit height (other unit height can be ordered by demand)

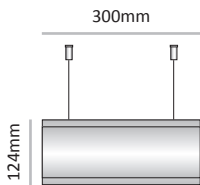

<b>Cat. No.</b>	LP-DS-L-124-300
<b>Unit Width</b>	300 mm
<b>Insert size</b>	105mm X 300mm

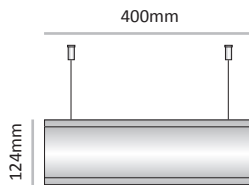

<b>Cat. No.</b>	LP-DS-L-124-400
<b>Unit Width</b>	400 mm
<b>Insert size</b>	105mm X 400mm

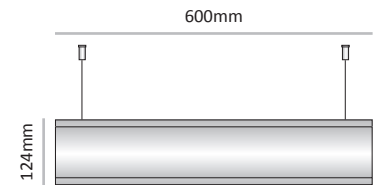

<b>Cat. No.</b>	LP-DS-L-124-600
<b>Unit Width</b>	600 mm
<b>Insert size</b>	105mm X 600mm

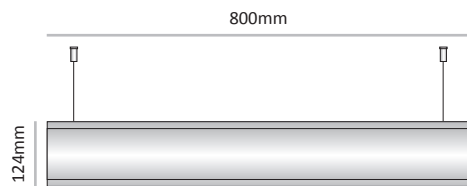

<b>Cat. No.</b>	LP-DS-L-124-800
<b>Unit Width</b>	800 mm
<b>Insert size</b>	105mm X 800mm

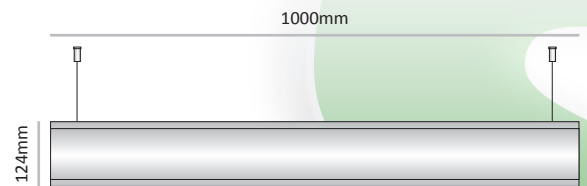

<b>Cat. No.</b>	LP-DS-L-124-1000
<b>Unit Width</b>	1000 mm
<b>Insert size</b>	105mm X 1000mm

LP-DS-L-168

Commonly used unit height (other unit height can be ordered by demand)

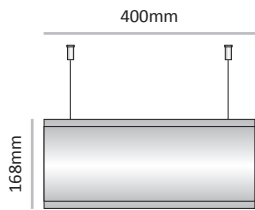

<b>Cat. No.</b>	LP-DS-L-168-400
<b>Unit Width</b>	400 mm
<b>Insert size</b>	150mm X 400mm

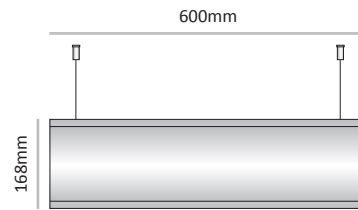

<b>Cat. No.</b>	LP-DS-L-168-600
<b>Unit Width</b>	600 mm
<b>Insert size</b>	150mm X 600mm

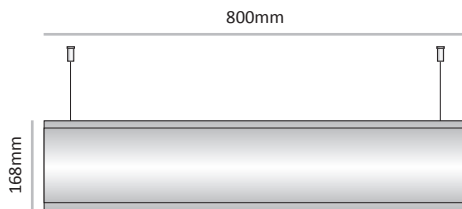

<b>Cat. No.</b>	LP-DS-L-168-800
<b>Unit Width</b>	800 mm
<b>Insert size</b>	150mm X 800mm

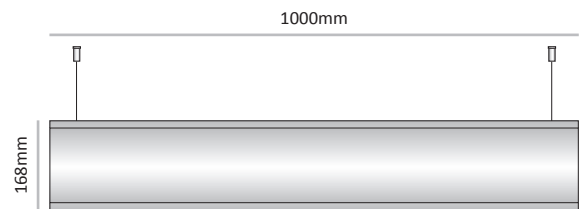

<b>Cat. No.</b>	LP-DS-L-168-1000
<b>Unit Width</b>	1000 mm
<b>Insert size</b>	150mm X 1000mm

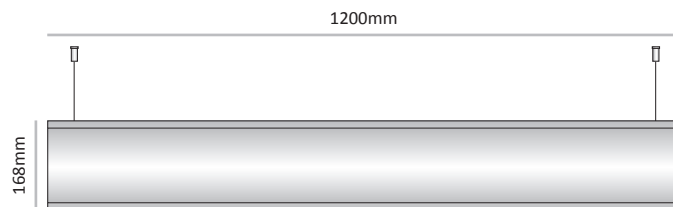

<b>Cat. No.</b>	LP-DS-L-168-1200
<b>Unit Width</b>	1200 mm
<b>Insert size</b>	150mm X 1200mm

LP-DS-L-230

Commonly used unit height (other unit height can be ordered by demand)

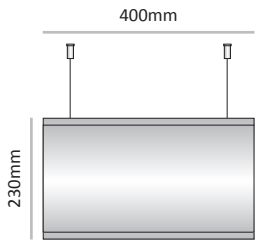

<b>Cat. No.</b>	LP-DS-L-230-400
<b>Unit Width</b>	400 mm
<b>Insert size</b>	210mm X 400mm

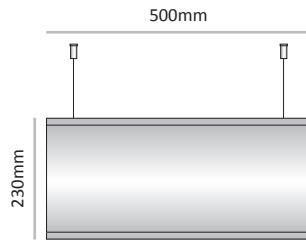

<b>Cat. No.</b>	LP-DS-L-230-500
<b>Unit Width</b>	500 mm
<b>Insert size</b>	210mm X 500mm

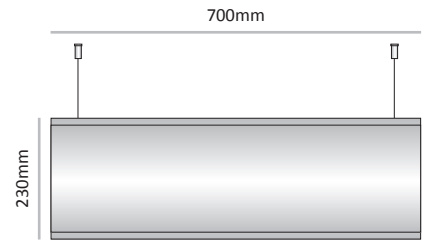

<b>Cat. No.</b>	LP-DS-L-230-700
<b>Unit Width</b>	700 mm
<b>Insert size</b>	210mm X 700mm

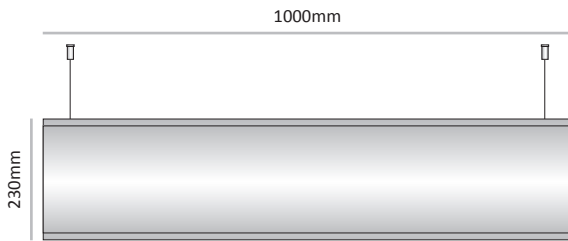

<b>Cat. No.</b>	LP-DS-L-230-1000
<b>Unit Width</b>	1000 mm
<b>Insert size</b>	210mm X 1000mm

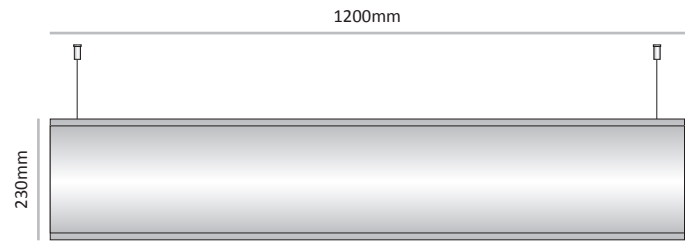

<b>Cat. No.</b>	LP-DS-L-230-1200
<b>Unit Width</b>	1200 mm
<b>Insert size</b>	210mm X 1200mm

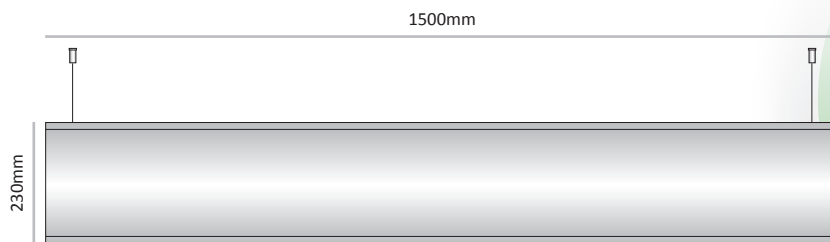

<b>Cat. No.</b>	LP-DS-L-230-1500
<b>Unit Width</b>	1500 mm
<b>Insert size</b>	210mm X 1500mm

LP-DS-L-320

Commonly used unit height (other unit height can be ordered by demand)

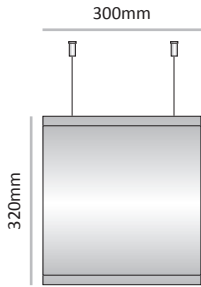

<b>Cat. No.</b>	LP-DS-L-320-300
<b>Unit Width</b>	300 mm
<b>Insert size</b>	297mm X 300mm

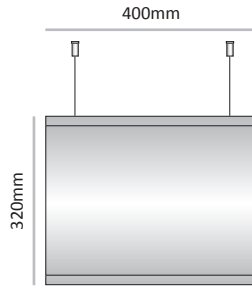

<b>Cat. No.</b>	LP-DS-L-320-400
<b>Unit Width</b>	400 mm
<b>Insert size</b>	297mm X 400mm

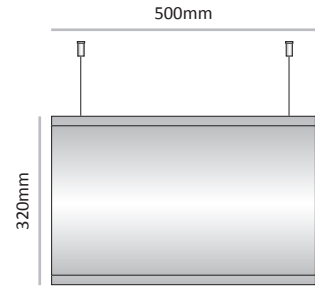

<b>Cat. No.</b>	LP-DS-L-320-500
<b>Unit Width</b>	500 mm
<b>Insert size</b>	297mm X 500mm

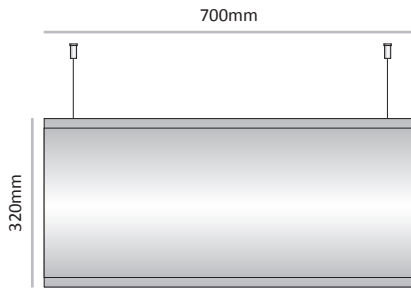

<b>Cat. No.</b>	LPD-DS-L-320-700
<b>Unit Width</b>	700 mm
<b>Insert size</b>	297mm X 700mm

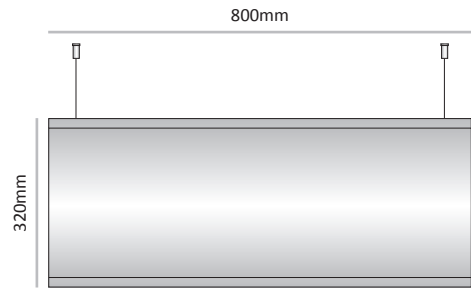

<b>Cat. No.</b>	LPD-DS-L-320-800
<b>Unit Width</b>	800 mm
<b>Insert size</b>	297mm X 800mm

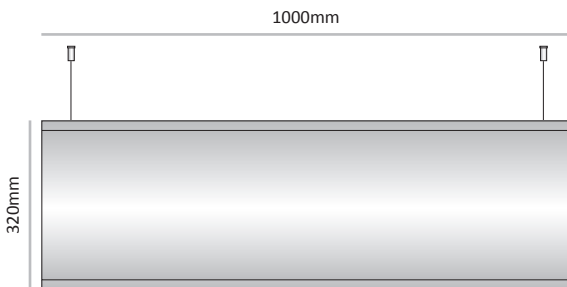

<b>Cat. No.</b>	LPD-DS-L-320-1000
<b>Unit Width</b>	1000 mm
<b>Insert size</b>	297mm X 1000mm

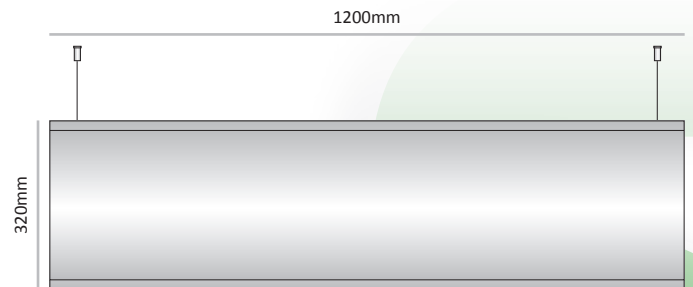

<b>Cat. No.</b>	LPD-DS-L-320-1200
<b>Unit Width</b>	1200 mm
<b>Insert size</b>	297mm X 1200mm

