



LPPF-L is a projecting flag sign in a landscape configuration.

This elegant yet simple and straight forward double sided projecting flag sign is created by attaching two Leader Prestige profiles back to back, bolted to an oval shaped anodized aluminum base plate.

The LPPF-L is available in five heights: 94, 124, 168, 230 and 320mm with endless length options.

All presented length options are commonly used sizes; however, customized lengths are available upon request.

The Leader prestige features unique rounded micro snap side profiles, allowing a fast and simple insert change without compromising its elegance. The side clips are offered in 5 spectacular colored anodized finishes: Silver, gold, black, red, and blue.

The Leader Prestige's profile's smooth face is great for direct vinyl graphics application or printed paper inserts as well.

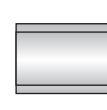



1

Five standard profile height options: 94, 124, 168, 230 and 320mm.

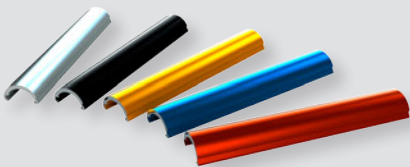

2

Side clips are offered in 5 colored anodized finishes: silver, gold, black, red and blue.

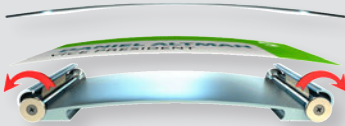

3

Swivel side snap clip profiles outward to remove inserts.



4

Double sided anodized aluminum cap and oval base plate are positioned on the sides to hold the two back to back Leader Prestige projecting profiles

LPPF-L-H-W-CF	
LPPF	System Type - Leader Prestige Projecting Flags
L	Sign layout - Landscape
H	Sign Unit Height - mm
W	Sign Unit Width - mm
CF	Clips Finish S = Silver anodized G = Gold anodized R = Red anodized BL = Blue anodized BK = Black anodized

LPPF-L-94

Commonly used unit height (other unit height can be ordered by demand)

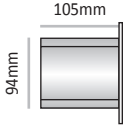
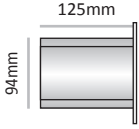
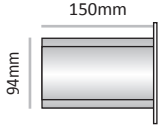
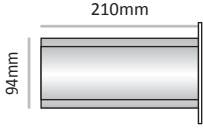
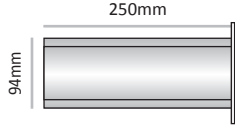

				
Cat. No. LPPF-L-94-105 Unit Width 105 mm Insert size 75mm X 105mm	Cat. No. LPPF-L-94-125 Unit Width 125 mm Insert size 75mm X 125mm	Cat. No. LPPF-L-94-150 Unit Width 150 mm Insert size 75mm X 150mm	Cat. No. LPPF-L-94-210 Unit Width 210 mm Insert size 75mm X 210mm	Cat. No. LPPF-L-94-250 Unit Width 250 mm Insert size 75mm X 250mm

LPPF-L-124

Commonly used unit width (other unit width can be ordered by demand)

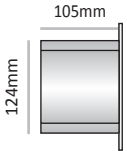
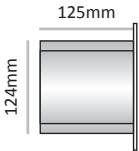
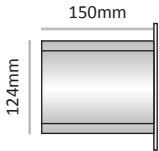
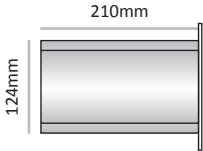
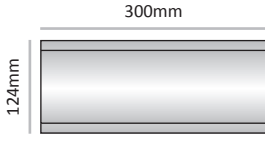

				
Cat. No. LPPF-L-124-105 Unit Width 105 mm Insert size 105mm X 105mm	Cat. No. LPPF-L-124-125 Unit Width 125 mm Insert size 105mm X 125mm	Cat. No. LPPF-L-124-150 Unit Width 150 mm Insert size 105mm X 150mm	Cat. No. LPPF-L-124-210 Unit Width 210 mm Insert size 105mm X 210mm	Cat. No. LPPF-L-124-300 Unit Width 300 mm Insert size 105mm X 300mm

LPPF-L-168

Commonly used unit width (other unit width can be ordered by demand)

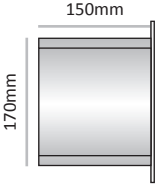
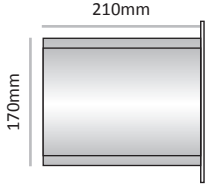
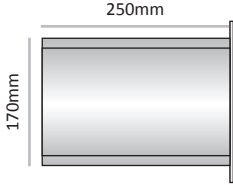
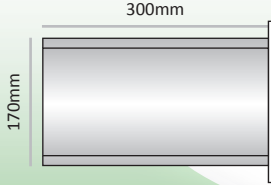

			
Cat. No. LPPF-L-168-150 Unit Width 150 mm Insert size 150mm X 150mm	Cat. No. LPPF-L-168-210 Unit Width 210 mm Insert size 150mm X 210mm	Cat. No. LPPF-L-168-250 Unit Width 250 mm Insert size 150mm X 250mm	Cat. No. LPPF-L-168-300 Unit Width 300 mm Insert size 150mm X 300mm

LPPF-L-230

Commonly used unit height (other unit height can be ordered by demand)

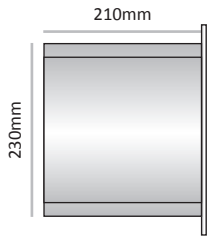

Cat. No.	LPPF-L-230-210
Unit Width	210 mm
Insert size	210mm X 210mm

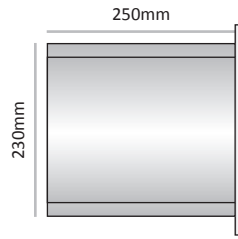

Cat. No.	LPPF-L-230-250
Unit Width	250 mm
Insert size	210mm X 250mm

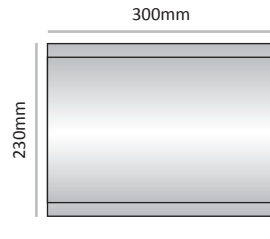

Cat. No.	LPPF-L-230-300
Unit Width	300 mm
Insert size	210mm X 300mm

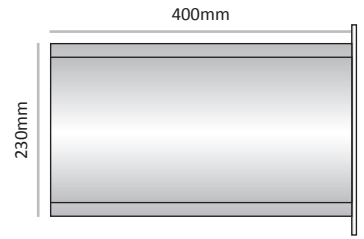

Cat. No.	LPPF-L-230-400
Unit Width	400 mm
Insert size	210mm X 400mm

LPPF-L-320

Commonly used unit height (other unit height can be ordered by demand)

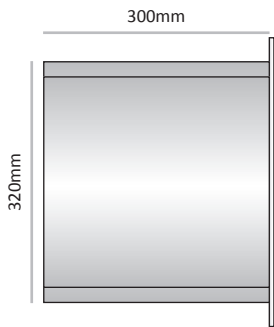
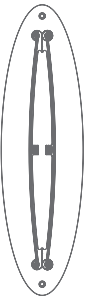

Cat. No.	LPPF-L-320-300
Unit Width	300 mm
Insert size	300mm X 300mm

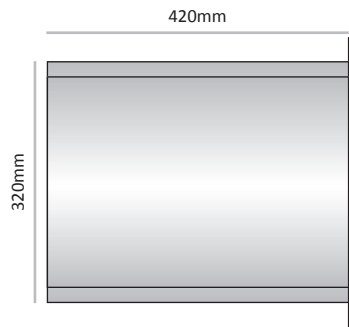

Cat. No.	LPPF-L-320-420
Unit Width	420 mm
Insert size	300mm X 420mm

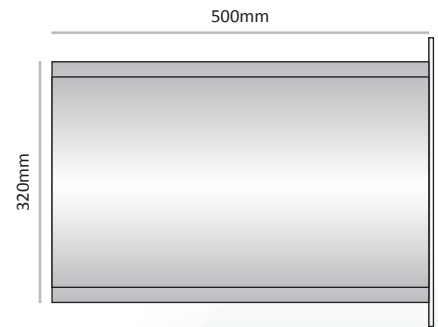

Cat. No.	LPPF-L-320-500
Unit Width	500 mm
Insert size	300mm X 500mm