



**LVD-DS-P** is a double sided suspended sign frame in a portrait configuration.

A lightweight aluminum body frame makes the LVD-DS-P a rigid yet lightweight suspended sign unit, suitable for use in light tile ceiling.

The LVD-DS-P is available in ten standard widths, ranging from 320mm to 1200mm with endless height options.

All presented height options are commonly used sizes; however, customized heights are available upon request.

The installation can be done by using chrome plated auto lock cable grip ceiling anchors.

For this sign system, we offer three face type options:

AA- Full size Anodized Aluminum face.

AAS- Individual Anodized Aluminum Strips for multiple slot signs (strips height are cut to size to meet customer's needs).

AC- Mill finish Aluminum sheet with Clear lens cover, for printed paper inserts.

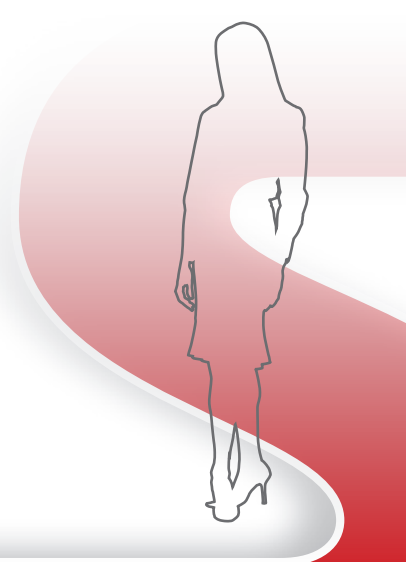
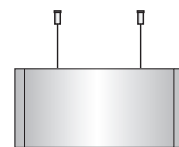



1

An easy insert removal using our silicone suction cup



3

Multiline individual stripes sign with direct application of vinyl graphics



2

Installation can be done by using chrome plated auto lock cable grip ceiling anchors and PVC coated steel cable



4

A lightweight aluminum body frame suitable for use in light tile ceiling

**LVD-DS-P-W-H-FT**

LVD	System Type - Leader View Director
DS	Double Sided
P	Sign layout - Portrait
W	Sign Unit Width - mm
H	Sign Unit Height - mm
FT	Face type AA=Anodised Aluminum AAS=Anodised Aluminum Stripes AC=Aluminum+Clear cover

### LVD-DS-P-320

Commonly used unit height (other unit height can be ordered by demand)

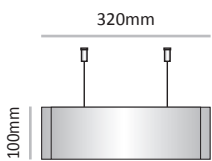

<b>Cat. No.</b>	LVD-DS-P-320-100
<b>Unit Height</b>	100 mm
<b>Insert size</b>	297mm X 100mm

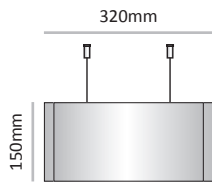

<b>Cat. No.</b>	LVD-DS-P-320-150
<b>Unit Height</b>	150 mm
<b>Insert size</b>	297mm X 150mm

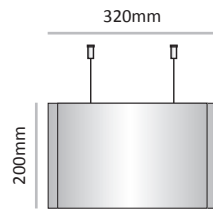

<b>Cat. No.</b>	LVD-DS-P-320-200
<b>Unit Height</b>	200 mm
<b>Insert size</b>	297mm X 200mm

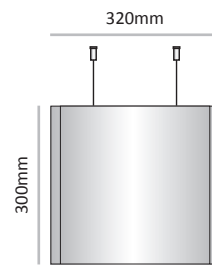

<b>Cat. No.</b>	LVD-DS-P-320-300
<b>Unit Height</b>	300 mm
<b>Insert size</b>	297mm X 300mm

### LVD-DS-P-400

Commonly used unit height (other unit height can be ordered by demand)

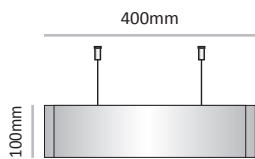

<b>Cat. No.</b>	LVD-DS-P-400-100
<b>Unit Height</b>	100 mm
<b>Insert size</b>	381mm X 100mm

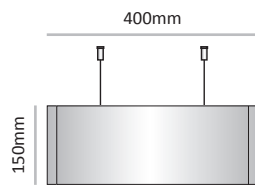

<b>Cat. No.</b>	LVD-DS-P-400-150
<b>Unit Height</b>	150 mm
<b>Insert size</b>	381mm X 150mm

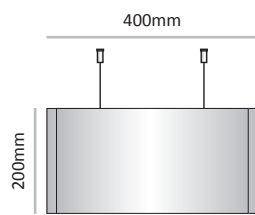

<b>Cat. No.</b>	LVD-DS-P-400-200
<b>Unit Height</b>	200 mm
<b>Insert size</b>	381mm X 200mm

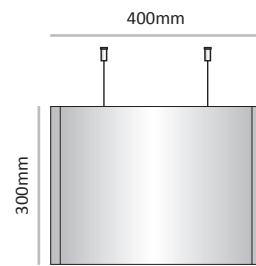

<b>Cat. No.</b>	LVD-DS-P-400-300
<b>Unit Height</b>	300 mm
<b>Insert size</b>	381mm X 300mm

### LVD-DS-P-500

Commonly used unit height (other unit height can be ordered by demand)

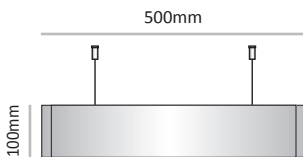

<b>Cat. No.</b>	LVD-DS-P-500-100
<b>Unit Height</b>	100 mm
<b>Insert size</b>	484mm X 100mm

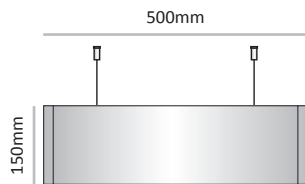

<b>Cat. No.</b>	LVD-DS-P-500-150
<b>Unit Height</b>	150 mm
<b>Insert size</b>	484mm X 150mm

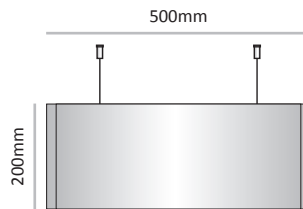

<b>Cat. No.</b>	LVD-DS-P-500-200
<b>Unit Height</b>	200 mm
<b>Insert size</b>	484mm X 200mm

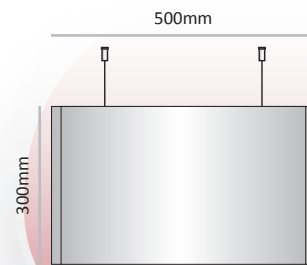

<b>Cat. No.</b>	LVD-DS-P-500-300
<b>Unit Height</b>	300 mm
<b>Insert size</b>	484mm X 300mm

## LVD-DS-P-600

Commonly used unit height (other unit height can be ordered by demand)

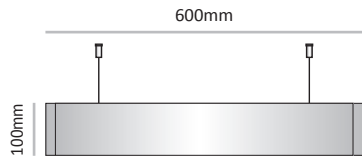

<b>Cat. No.</b>	LVD-DS-P-600-100
<b>Unit Height</b>	100 mm
<b>Insert size</b>	584mm X 100mm

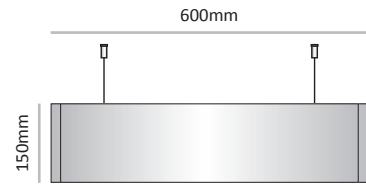

<b>Cat. No.</b>	LVD-DS-P-600-150
<b>Unit Height</b>	150 mm
<b>Insert size</b>	584mm X 150mm

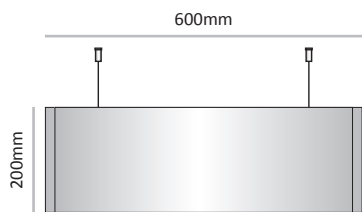

<b>Cat. No.</b>	LVD-DS-P-600-200
<b>Unit Height</b>	200 mm
<b>Insert size</b>	584mm X 200mm

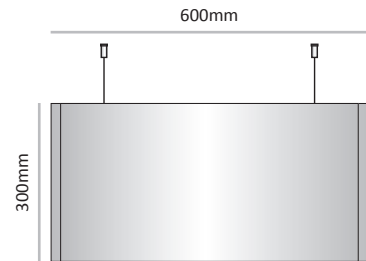

<b>Cat. No.</b>	LVD-DS-P-600-300
<b>Unit Height</b>	300 mm
<b>Insert size</b>	584mm X 300mm

## LVD-DS-P-700

Commonly used unit height (other unit height can be ordered by demand)

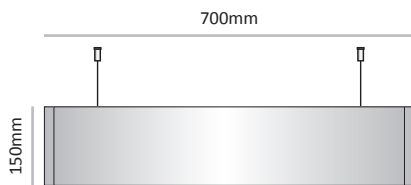

<b>Cat. No.</b>	LVD-DS-P-700-150
<b>Unit Height</b>	150 mm
<b>Insert size</b>	684mm X 150mm

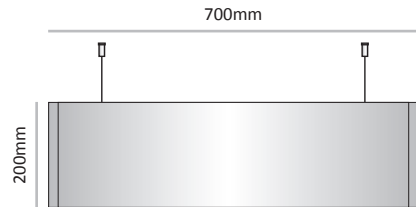

<b>Cat. No.</b>	LVD-DS-P-700-200
<b>Unit Height</b>	200 mm
<b>Insert size</b>	684mm X 200mm

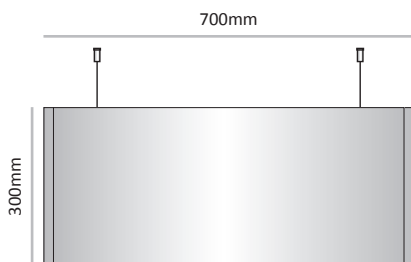

<b>Cat. No.</b>	LVD-DS-P-700-300
<b>Unit Height</b>	300 mm
<b>Insert size</b>	684mm X 300mm

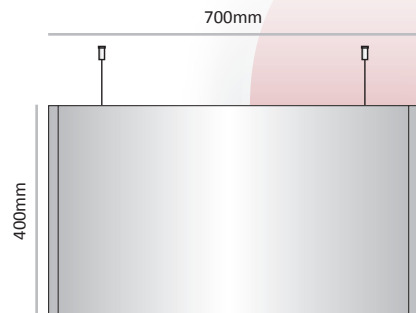

<b>Cat. No.</b>	LVD-DS-P-700-400
<b>Unit Height</b>	400 mm
<b>Insert size</b>	684mm X 400mm

## LVD-DS-P-800

Commonly used unit height (other unit height can be ordered by demand)

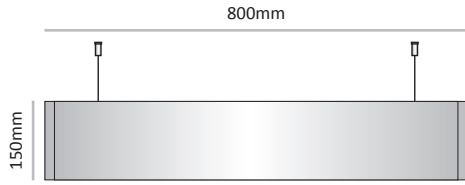

<b>Cat. No.</b>	LVD-DS-P-800-150
<b>Unit Height</b>	150 mm
<b>Insert size</b>	785mm X 150mm

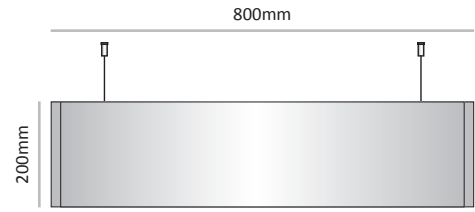

<b>Cat. No.</b>	LVD-DS-P-800-200
<b>Unit Height</b>	200 mm
<b>Insert size</b>	785mm X 200mm

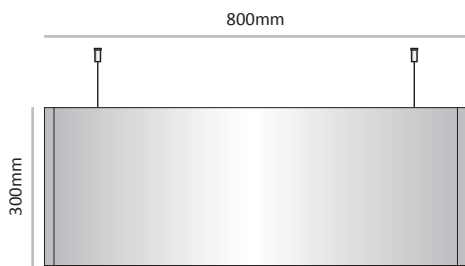

<b>Cat. No.</b>	LVD-DS-P-800-300
<b>Unit Height</b>	300 mm
<b>Insert size</b>	785mm X 300mm

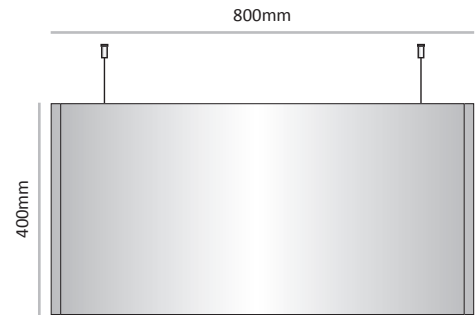

<b>Cat. No.</b>	LVD-DS-P-800-400
<b>Unit Height</b>	400 mm
<b>Insert size</b>	785mm X 400mm

## LVD-DS-P-900

Commonly used unit height (other unit height can be ordered by demand)

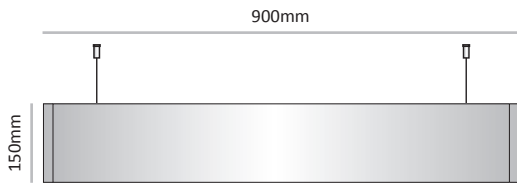

<b>Cat. No.</b>	LVD-DS-P-900-150
<b>Unit Height</b>	150 mm
<b>Insert size</b>	885mm X 150mm

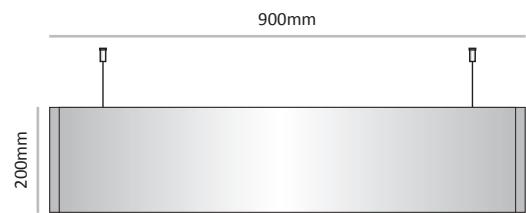

<b>Cat. No.</b>	LVD-DS-P-900-200
<b>Unit Height</b>	200 mm
<b>Insert size</b>	885mm X 200mm

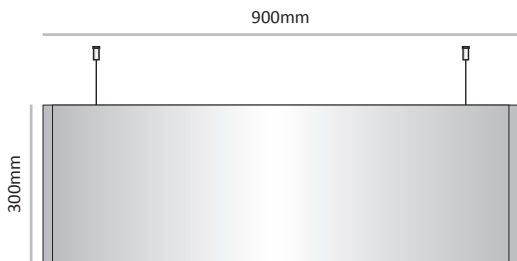

<b>Cat. No.</b>	LVD-DS-P-900-300
<b>Unit Height</b>	300 mm
<b>Insert size</b>	885mm X 300mm

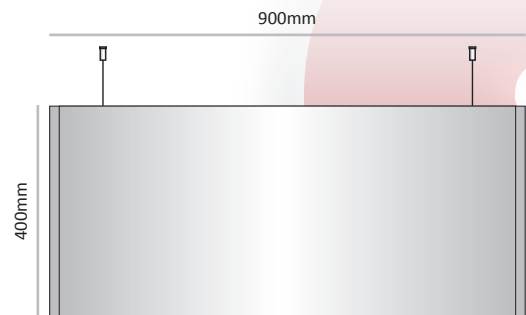

<b>Cat. No.</b>	LVD-DS-P-900-400
<b>Unit Height</b>	400 mm
<b>Insert size</b>	885mm X 400mm

# LVD-DS-P-1000

Commonly used unit height (other unit height can be ordered by demand)

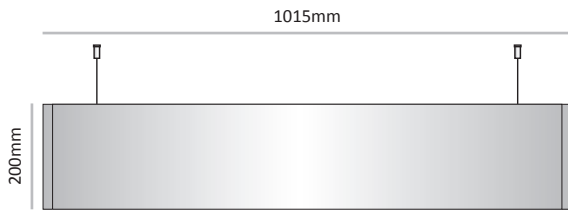
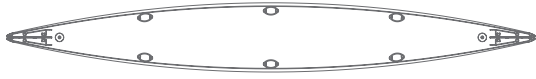

<b>Cat. No.</b>	LVD-DS-P-1000-200
<b>Unit Height</b>	200 mm
<b>Insert size</b>	1000mm X 200mm

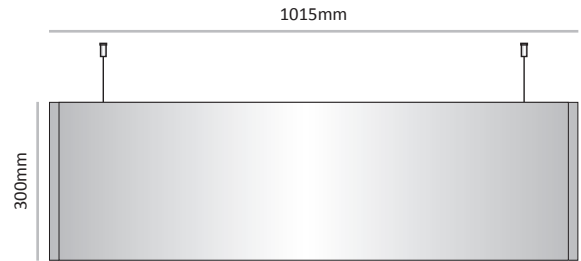

<b>Cat. No.</b>	LVD-DS-P-1000-300
<b>Unit Height</b>	300 mm
<b>Insert size</b>	1000mm X 300mm

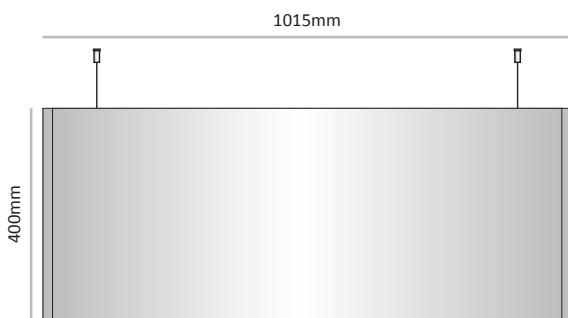

<b>Cat. No.</b>	LVD-DS-P-1000-400
<b>Unit Height</b>	400 mm
<b>Insert size</b>	1000mm X 400mm

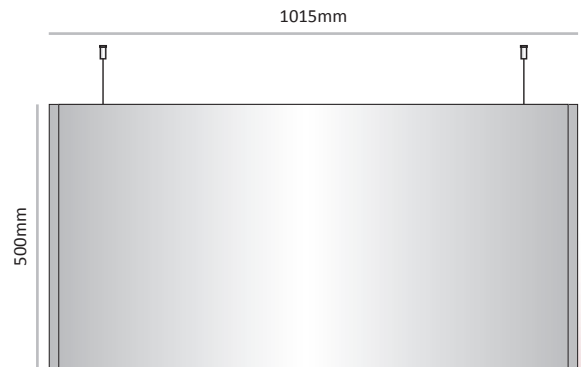

<b>Cat. No.</b>	LVD-DS-P-1000-500
<b>Unit Height</b>	500 mm
<b>Insert size</b>	1000mm X 500mm

## LVD-DS-P-1200

Commonly used unit height (other unit height can be ordered by demand)

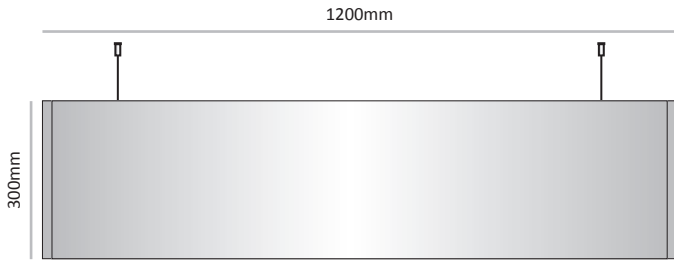
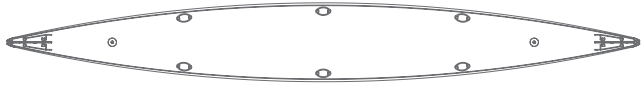

<b>Cat. No.</b>	LVD-DS-P-1200-300
<b>Unit Height</b>	300 mm
<b>Insert size</b>	1185mm X 300mm

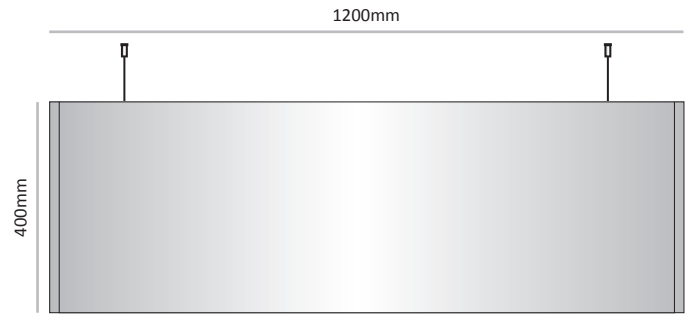

<b>Cat. No.</b>	LVD-DS-P-1200-400
<b>Unit Height</b>	400 mm
<b>Insert size</b>	1185mm X 400mm

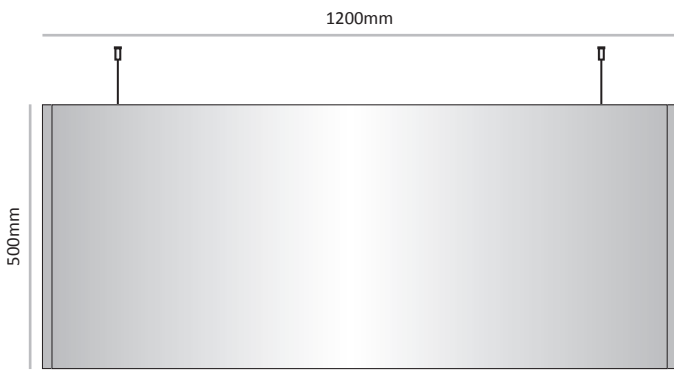

<b>Cat. No.</b>	LVD-DS-P-1200-500
<b>Unit Height</b>	500 mm
<b>Insert size</b>	1185mm X 500mm

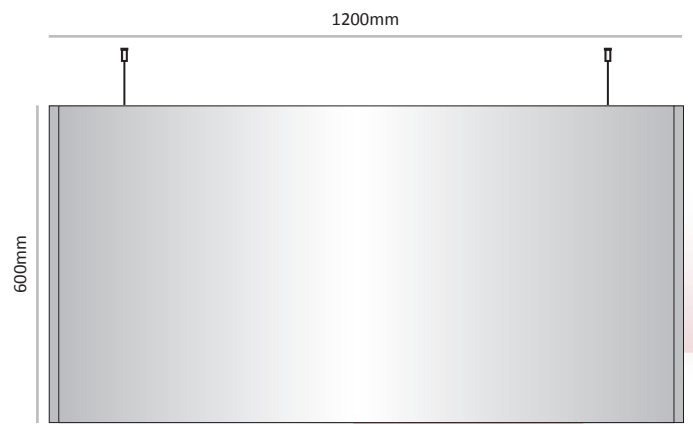

<b>Cat. No.</b>	LVD-DS-P-1200-600
<b>Unit Height</b>	600 mm
<b>Insert size</b>	1185mm X 600mm